

RoHS



- 1. MATERIAL SPECIFICATION:
 - 1.1 INSULATION: NYLON 66 UL 94V-0/2
 - 1.2 CONTACT: COPPER ALLOY SQ 1.14mm

2. FINISH: BRIGHT TIN PLATED

3. BILL OF PART NO:

3961WR-XP-BX-XX-XXX-HF

NO. OF CIRCUITS →

COLOR: BLANK=NATURAL OR A~U

VOID CIRCUIT: BLANK (STANDARD) OR 1~3 ALPHANUMERIC DIGITS

INSULATION MATERIAL:
 BLANK=NYLON 66 UL 94V-2
 66=NYLON 66 UL 94V-0

4. FOR COLOR, FINISH, VOID PIN, AVAILABILITY, DELIVERY AND MOQ, PLEASE CONTACT CKM.

5. DIMENSIONAL & ORDERING INFORMATION

POS	A	B
2	3.96	7.92
3	7.92	11.88
4	11.88	15.84
5	15.84	19.80
6	19.80	23.76
7	23.76	27.72
8	27.72	31.68
9	31.68	35.64
10	35.64	39.60
11	39.60	43.56
12	43.56	47.52
13	47.52	51.48
14	51.48	55.44
15	55.44	59.40
16	59.40	63.36
17	63.36	67.32
18	67.32	71.28
19	71.28	75.24
20	75.24	79.20

CODING	COLOR
BLANK	NATURAL
A	BLACK
B	BROWN
C	RED
D	ORANGE
E	YELLOW
F	GREEN
G	BLUE
H	PURPLE
J	GREY
K	WHITE
M	MILKY YELLOW
Q	BRICK RED
U	MILKY WHITE

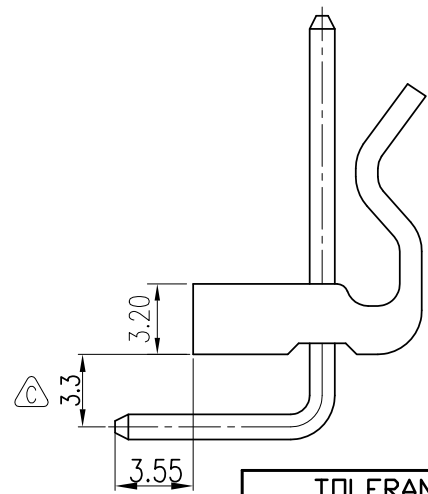
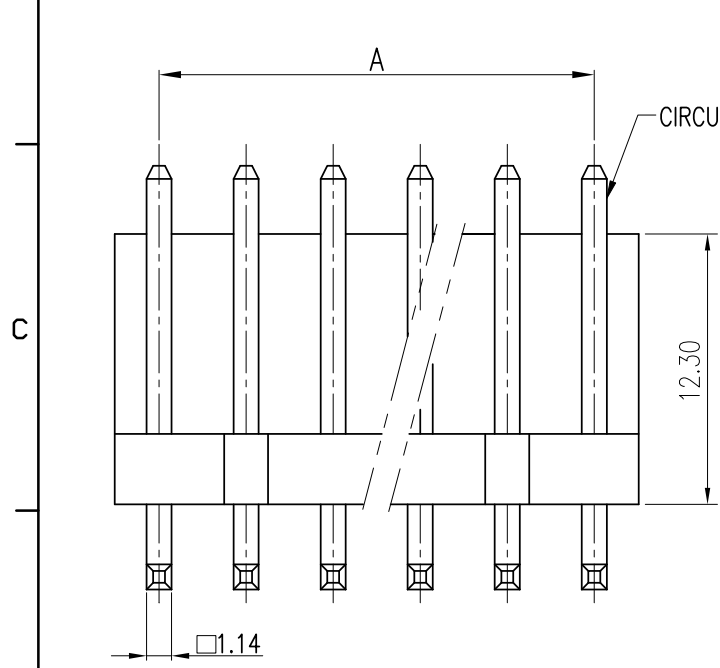
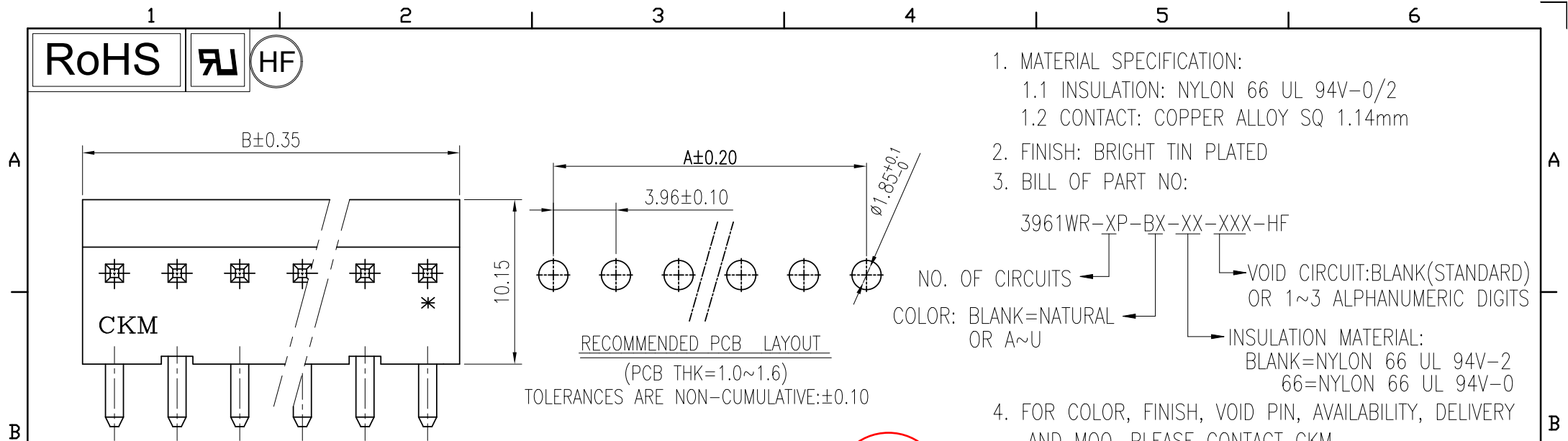

TOLERANCE		PART NO.		朝貴電子股份有限公司 CKM ELECTRONICS CO., LTD.	
X.	X.XXX ±0.10	3961WR-XP-BX-XX-XXX-HF			
X.X	±0.40	DRAWING NO.		DESCRIPTION	
X.XX	±0.25	C-396102XX-XX		3.96mm PITCH RIGHT ANGLE DIP TYPE CONNECTOR	
		UNIT:		APPROVED BY	
		mm		Angus.Chen	
DWG TYPE.		CHECKED BY		DRAWN BY	
Customer Drawing		Sun.Lee		GuoXiang.Jiang	
		2023/06/26		2023/06/26	
		PAGE		REV.	
		1 OF 2		C	
		SCALE			
		3 : 1			

C	EC-23060141	ADD 3.3 DIMENSION	GuoXiang.Jiang	2023/06/26
B		ADD PACKGE DRAWING	GuoXiang.Jiang	2016/12/21
REV.	ECN NO	REVISION RECORD	DRAW	DATE

1 RoHS

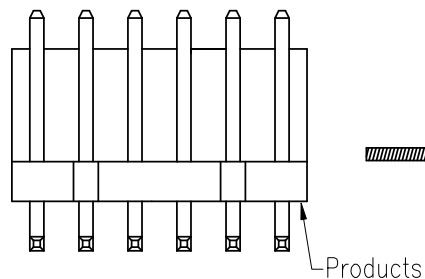

Products

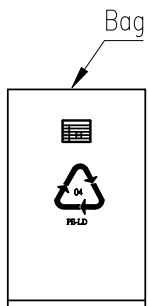

Bag

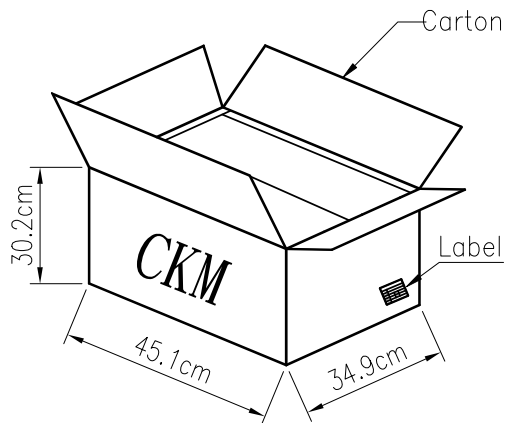

Carton

Label

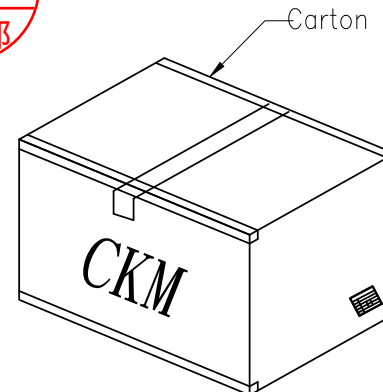

Carton



Stick by the label

POS	Bag	Carton	Weight	
	Pcs/Bag	Pcs/Carton	N/W(kg)	G/W(kg)
02	1000	30000	20.70	21.30
03	1000	15000	15.15	15.75
04	1000	12000	15.84	16.44
05	1000	8000	13.12	13.72
06	1000	8000	15.68	16.28
07	1000	7000	15.96	16.56
08	1000	6000	15.6	16.20
09	1000	4000	11.68	12.28
10	500	4000	12.96	13.56
11	500	4000	14.24	14.84
12	500	3000	11.64	12.24
13	500	2000	8.40	9.00
14	500	2000	9.04	9.64
15	500	2000	9.68	10.28
16	500	2000	10.32	10.92
17	500	1500	8.22	8.82
18	500	1500	8.70	9.30
19	500	1500	9.18	9.78
20	500	1500	9.66	10.26

TOLERANCE		PART NO.		朝貴電子股份有限公司 CKM ELECTRONICS CO., LTD.	
X.	X.XXX ±0.10	3961WR-XP-BX-XX-XXX-HF			
X.X	±0.40	DRAWING NO.		DESCRIPTION	
X.XX	±0.25	C-396102XX-XX		3.96mm PITCH RIGHT ANGLE DIP TYPE CONNECTOR	
		UNIT:		APPROVED BY	
		mm		Angus.Chen	
DWG TYPE.		CHECKED BY		DRAWN BY	
Customer Drawing		Sun.Lee		GuoXiang.Jiang	
		2023/06/26		2023/06/26	
		PAGE		REV.	
		2 OF 2		C	
		SCALE			
		3 : 1			

C	EC-23060141	ADD 3.3 DIMENSION	GuoXiang.Jiang	2023/06/26
B		ADD PACKGE DRAWING	GuoXiang.Jiang	2016/12/21
REV.	ECN NO	REVISION RECORD	DRAW	DATE