

RoHS



CUST INFORMATION.

PART NO.	DRAWING NO.	REV.
----------	-------------	------

A

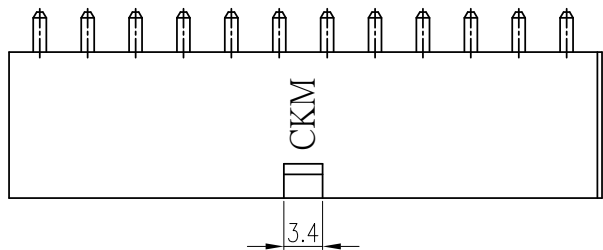

B

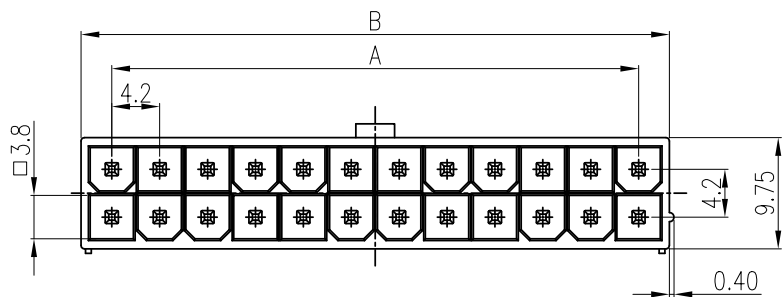

C

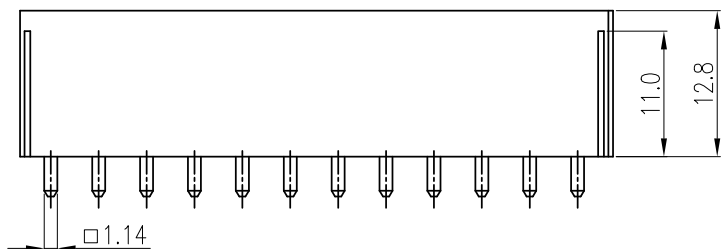

D

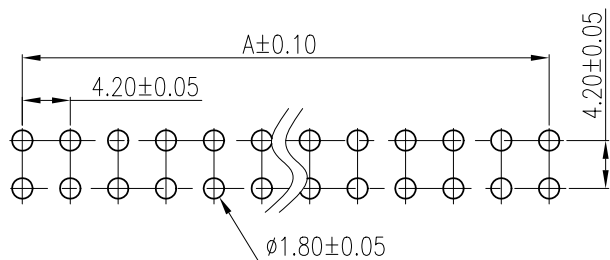

RECOMMENDED PCB LAYOUT

NOTES:

- MATERIAL: NYLON 66 OR LCP, UL 94V-0
- CONTACT MATERIAL: SQ 1.14mm COPPER ALLOY
- BILL OF PART No.
CKM4203-WVI-XX-XX-X-X-XX
POS: 02~24
INSULATOR MATERIAL:
1=NYLON 66,UL 94V-0(NATURAL)
2=NYLON 66,UL 94V-2(NATURAL)
3=NYLON 66,UL 94V-0(BLACK)
4=LCP,UL 94V-0(BLACK)
5=NYLON 66,UL 94V-2(BLACK)
6=LCP,UL 94V-0(NATURAL)
1A=NYLON 66,UL 94V-0(BLACK)
1C=NYLON 66,UL 94V-0(RED)
1G=NYLON 66,UL 94V-0(BLUE)
4G=LCP,UL 94V-0(BLUE)
4J=LCP,UL 94V-0(GRAY)

PACKAGE: BLANK=TRAY PACKAGE
DP=TUBE PACKAGE

CONTACT MATERIAL:
BLANK=HIGH CONDUCTIVITY
COPPER ALLOY
OR B=BRASS

FINISH:
0=GOLD FLASH
1=100u" MATTE-TIN PLATED
2=100u" TIN PLATED
3=15u" GOLD PLATED
4=30u" GOLD PLATED

4. DIMENSIONAL

POS	A	B	POS	A	B
02	--	5.4	14	25.2	30.6
04	4.2	9.6	16	29.4	34.8
06	8.4	13.8	18	33.6	39.0
08	12.6	18.0	20	37.8	43.2
10	16.8	22.2	22	42.0	47.4
12	21.0	26.4	24	46.2	51.6



5. FOR COLOR, FINISH, AVAILABILITY, DELIVERY & MOQ, PLEASE CONTACT CKM

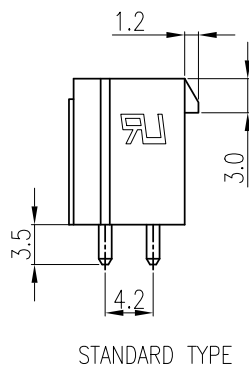

STANDARD TYPE

TOLERANCE		PART NO.		朝貴電子股份有限公司	
X. X.XXX ±0.10	X.XXX ±0.10	CKM4203-WVI-XX-XX-X-X-XX		CKM ELECTRONICS CO., LTD.	
X.X ±0.30	Angular ±2°	DRAWING NO.		TITLE.	
X.XX ±0.20		C-CKM4203-WVI-XX-XX-X-X-XX		4.2mm PITCH VERTICAL DIP TYPE CONNECTOR	
		UNIT:	APPROVED BY	CHECKED BY	DRAWN BY
		mm	Angus.Chen	Sun.Lee	GuoXiang.Jiang
DWG TYPE.		SCALE		PAGE	REV.
Customer Drawing		2 : 1		1 OF 4	E
		2023.04.06	2023.04.06	2023.04.06	

E	EC-23041501	ADD BLUE/GRAY OPTION	GuoXiang.Jiang	2023/04/06
D	EC-21121098	CHANGE THE TUBE PACKAGE QUANTITY	GuoXiang.Jiang	2021/12/29
REV.	ECN NO	REVISION RECORD	DRAW	DATE

A

B

C

D

1 RoHS



6 CUST INFORMATION.

PART NO. DRAWING NO. REV.

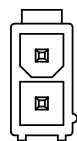

2*1

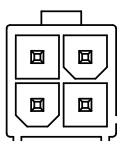

2*2

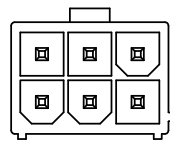

2*3

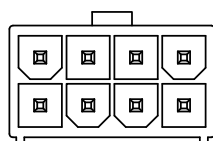

2*4

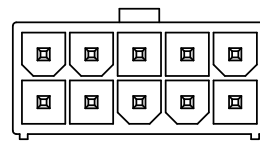

2*5

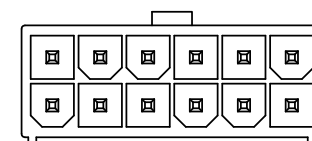

2*6

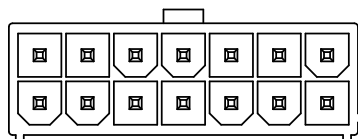

2*7

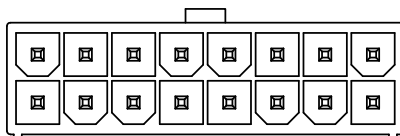

2*8

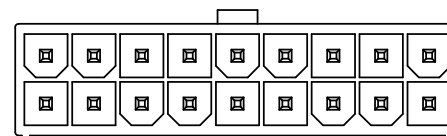

2*9

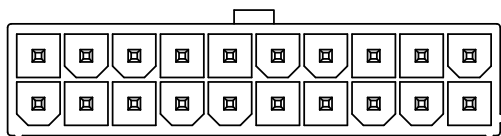

2*10

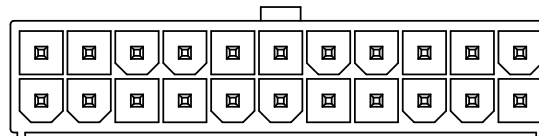

2*11

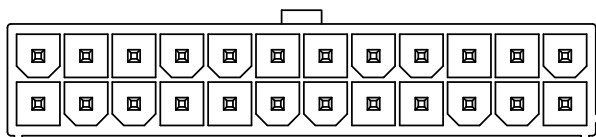

2*12



TOLERANCE		PART NO.		朝貴電子股份有限公司	
X.	X.XXX ±0.10	CKM4203-WVI-XX-XX-X-X-XX		CKM ELECTRONICS CO., LTD.	
X.X	±0.30	DRAWING NO.		TITLE.	
X.XX	±0.20	C-CKM4203-WVI-XX-XX-X-X-XX		4.2mm PITCH VERTICAL DIP TYPE CONNECTOR	
	Angular ±2°	APPROVED BY	CHECKED BY	DRAWN BY	PAGE
	UNIT: mm	Angus.Chen	Sun.Lee	GuoXiang.Jiang	2 OF 4
DWG TYPE.		2023.04.06	2023.04.06	2023.04.06	SCALE
Customer Drawing					2 : 1
					REV.
					E

E	EC-23041501	ADD BLUE/GRAY OPTION	GuoXiang.Jiang	2023/04/06
D	EC-21121098	CHANGE THE TUBE PACKAGE QUANTITY	GuoXiang.Jiang	2021/12/29
REV.	ECN NO	REVISION RECORD	DRAW	DATE

1 RoHS



6 CUST INFORMATION.

PART NO.	DRAWING NO.	REV.
----------	-------------	------

STACK 10 TRAYS TOGETHER

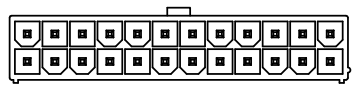

Products



TRAY BOTTOM COVER

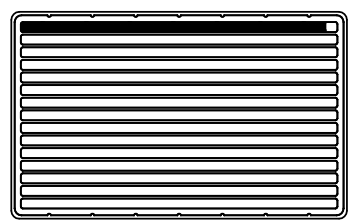

TRAY TOP COVER

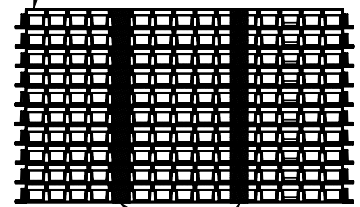

PE MEMBRANE

POS	PCS/TRAY	PCS/CARTON
02	1050	10500
04	600	6000
06	420	4200
08	315	3150
10	255	2550
12	225	2250
14	195	1950
16	165	1650
18	150	1500
20	135	1350
22	120	1200
24	105	1050



Stick by the label

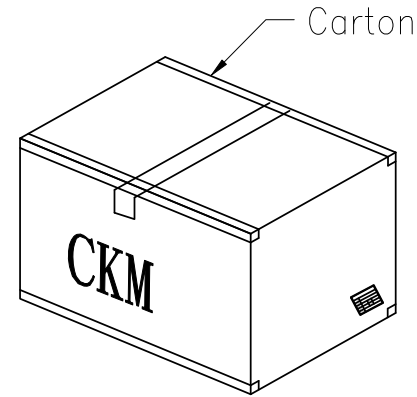

Carton

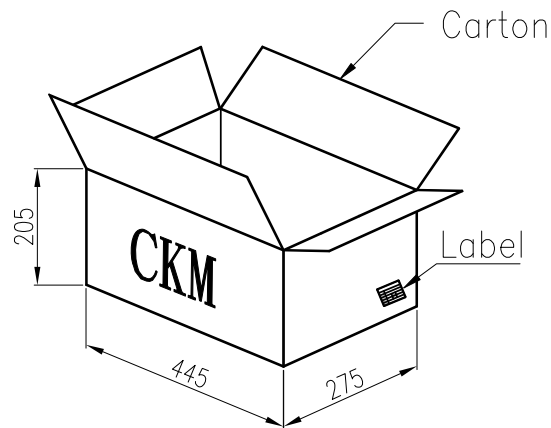

Carton

Label

TOLERANCE		PART NO.		朝貴電子股份有限公司	
X. X.X ±0.30	X.XXX ±0.10	CKM4203-WVI-XX-XX-X-X-XX		CKM ELECTRONICS CO., LTD.	
X.XX ±0.20	Angular ±2°	DRAWING NO.		TITLE.	
UNIT: mm		C-CKM4203-WVI-XX-XX-X-X-XX		4.2mm PITCH VERTICAL DIP TYPE CONNECTOR	
DWG TYPE. Customer Drawing		APPROVED BY	CHECKED BY	DRAWN BY	PAGE 3 OF 4
		Angus.Chen	Sun.Lee	GuoXiang.Jiang	SCALE 2 : 1
		2023.04.06	2023.04.06	2023.04.06	REV. E

E	EC-23041501	ADD BLUE/GRAY OPTION	GuoXiang.Jiang	2023/04/06
D	EC-21121098	CHANGE THE TUBE PACKAGE QUANTITY	GuoXiang.Jiang	2021/12/29
REV.	ECN NO	REVISION RECORD	DRAW	DATE

1 RoHS



6 CUST INFORMATION.

PART NO. DRAWING NO. REV.

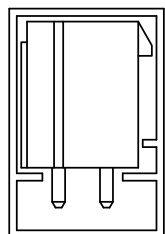

PRODUCTS

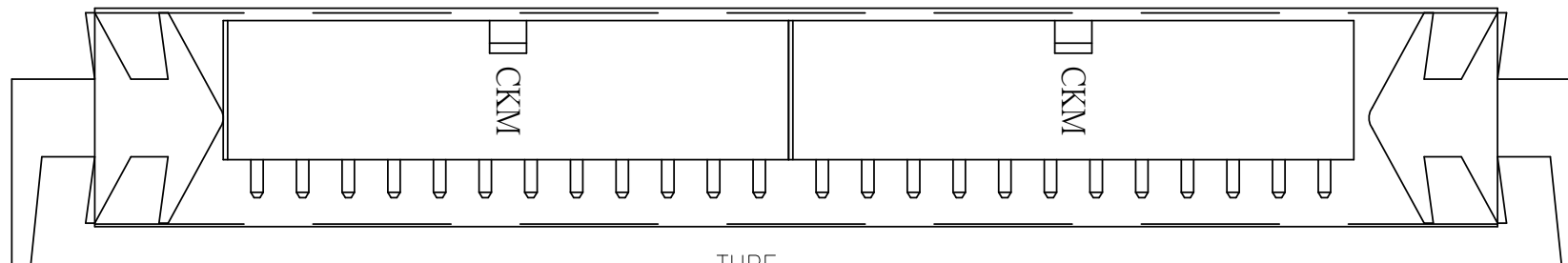

TUBE
500MM(L)*12.25MM(W)*18.8MM(H)

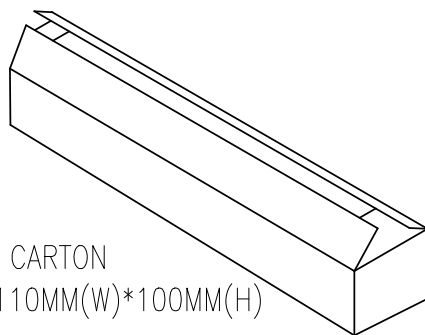

CARTON
515MM(L)*110MM(W)*100MM(H)

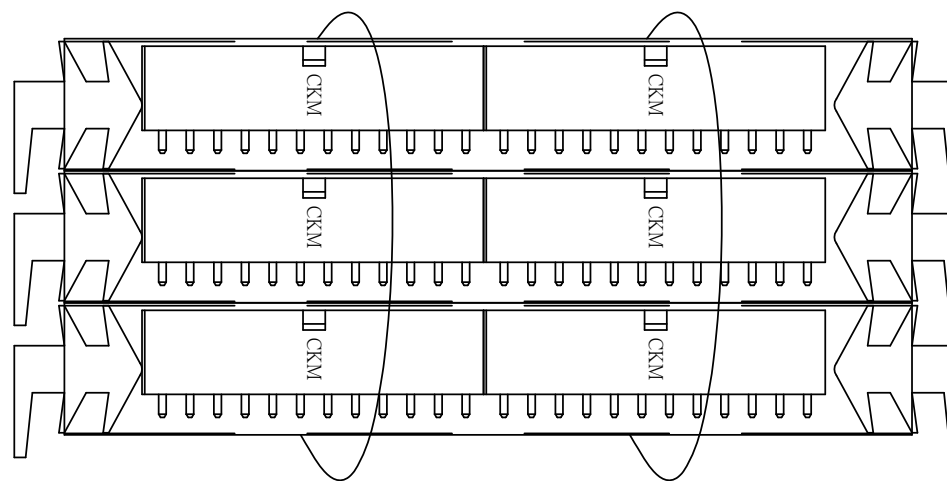

POS	PCS/TUBE	TUBE / CARTON	QUANTITY / PCS
02	78	32	2496
04	45		1440
06	32		1024
08	25		800
10	20		640
12	17		544
14	14		448
16	13		416
18	11		352
20	10		330
22	9		288
24	8		256

CKM
2023.04.12
研发部

TOLERANCE		PART NO.		朝貴電子股份有限公司	
X.	X.XXX ±0.10	CKM4203-WVI-XX-XX-X-X-XX		CKM ELECTRONICS CO., LTD.	
X.X	±0.30	DRAWING NO.		TITLE.	
X.XX	±0.20	C-CKM4203-WVI-XX-XX-X-X-XX		4.2mm PITCH VERTICAL DIP TYPE CONNECTOR	
UNIT: mm		APPROVED BY	CHECKED BY	DRAWN BY	PAGE
DWG TYPE.		Angus.Chen	Sun.Lee	GuoXiang.Jiang	4 OF 4
Customer Drawing		2023.04.06	2023.04.06	2023.04.06	SCALE
				2 : 1	
				REV. E	

E	EC-23041501	ADD BLUE/GRAY OPTION	GuoXiang.Jiang	2023/04/06
D	EC-21121098	CHANGE THE TUBE PACKAGE QUANTITY	GuoXiang.Jiang	2021/12/29
REV.	ECN NO	REVISION RECORD	DRAW	DATE