

1 2 3 4 5 6

RoHS

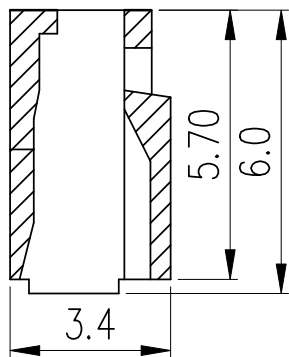

SEC A-A

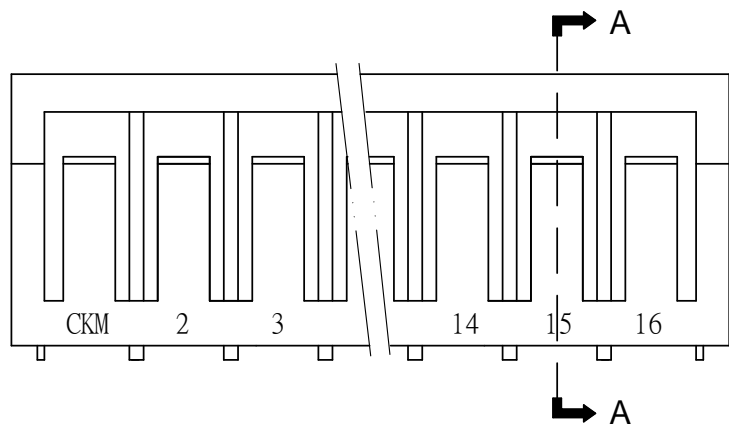
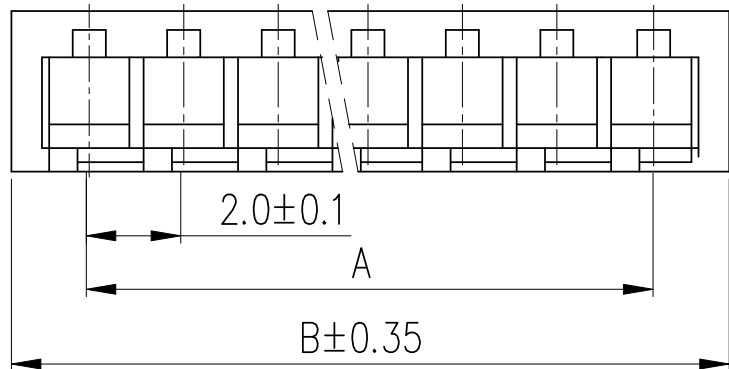

NOTE:

- 1. MATERIAL: NYLON 66 UL94 V-0
- 2. RoHS COMPLIANCE
- 3. BILL OF PART NO.

2002HR-XP-X-HF

COLOR: BLANK(NATURAL)
OR A THRU U

NO OF CIRCUITS: 2~16

- 4. FOR COLOR, AVAILABILITY, DELIVERY & MOQ, CONTACT CKM
- 5. DIMENSIONAL

POS	A	B
2	2.00	5.2
3	4.00	7.2
4	6.00	9.2
5	8.00	11.2
6	10.00	13.2
7	12.00	15.2
8	14.00	17.2
9	16.00	19.2
10	18.00	21.2
11	20.00	23.2
12	22.00	25.2
13	24.00	27.2
14	26.00	29.2
15	28.00	31.2
16	30.00	33.2

COLOR CODE	
BLANK	NATURAL
A	BLACK
C	RED
D	ORANGE



REV.	ECN NO	REVISION RECORD	DRAW	DATE
B		UPDATE DRAWING	WINNER	2017.03.24
A		NEW RELEASE	JIMMY	2016.03.25

TOLERANCE		PART NO.	朝貴電子股份有限公司 CKM ELECTRONICS CO., LTD.		
X. XXX ±0.10		2002HR-XP-X-HF	DESCRIPTION 2.0mm PITCH CRIMP TERMINAL SOCKET (HR)		
X.X ±0.40					
X.XX ±0.30	Angular ±2°	DRAWING NO. C-20020102-XX	APPROVED BY Angus.Chen 2017.03.24	CHECKED BY Angus.Chen 2017.03.24	DRAWN BY Winner 2017.03.24
UNIT: mm			PAGE 1 OF 2	REV. B	
DWG TYPE. Customer Drawing			SCALE 5 : 1		

RoHS



PE BAG : XXX PCS

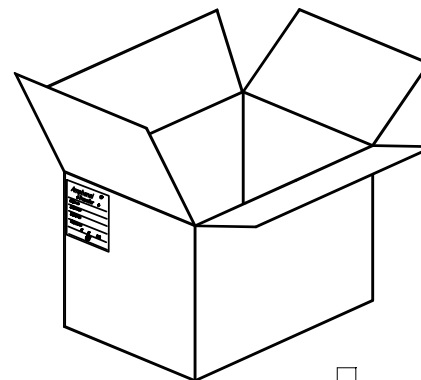
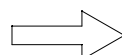
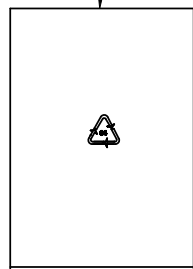
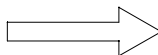
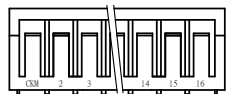

CARTON : XXXX PCS

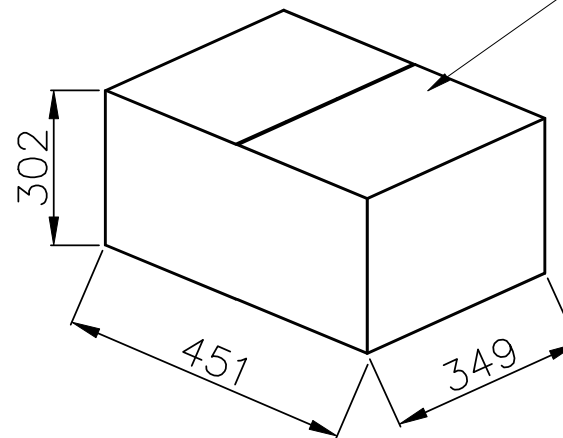

POS	PCS/PE BAG	PCS/CARTON
2	1000	260K
3	1000	170K
4	1000	140K
5	1000	120K
6	1000	90K
7	1000	80K
8	1000	80K
9	1000	65K
10	1000	60K
11	1000	45K
12	1000	45K
13	1000	40K
14	1000	35K
15	1000	35K
16	1000	35K



TOLERANCE X. X.X ±0.40 X.XX ±0.30 X.XXX ±0.10 Angular ±2°		PART NO. 2002HR-XP-X-HF		朝貴電子股份有限公司 CKM ELECTRONICS CO., LTD.	
		UNIT: mm		DRAWING NO. C- 20020102-XX	
DWG TYPE. Customer Drawing		APPROVED BY Angus.Chen 2017.03.24	CHECKED BY Angus.Chen 2017.03.24	DRAWN BY Winner 2017.03.24	PAGE 2 OF 2 SCALE 5 : 1
DESCRIPTION 2.0mm PITCH CRIMP TERMINAL SOCKET (HR)					
					REV. B

B		UPDATE DRAWING	WINNER	2017.03.24
A		NEW RELEASE	JIMMY	2016.03.25
REV.	ECN NO	REVISION RECORD	DRAW	DATE