

RoHS

HF

CKM
2021.08.23
研发部

NOTE:

- 1. MATERIAL: NYLON 66 UL94 V-0
- 2. RoHS & HALOGEN FREE COMPLIANCE
- 3. BILL OF PART NO.
2002HV-XP-X-HF

COLOR: BLANK(NATURAL)
OR A TO G

NO OF CIRCUITS: 2~16

- 4. FOR COLOR, AVAILABILITY, DELIVERY & MOQ, CONTACT CKM
- 5. DIMENSIONAL

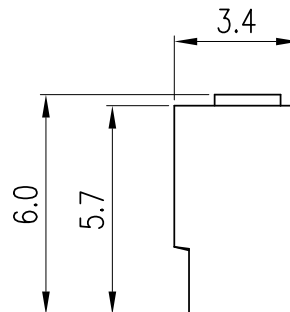
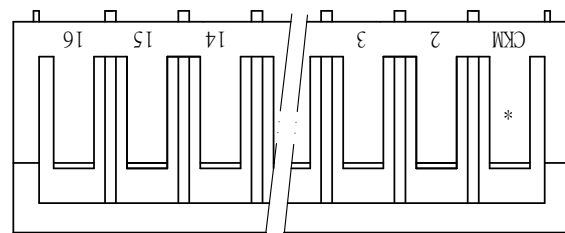
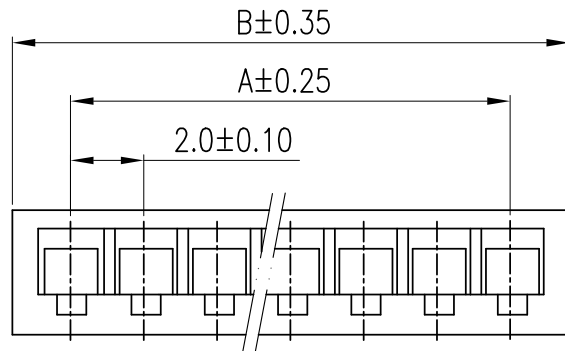

POS	A	B
2	/	5.2
3	4.0	7.2
4	6.0	9.2
5	8.0	11.2
6	10.0	13.2
7	12.0	15.2
8	14.0	17.2
9	16.0	19.2
10	18.0	21.2
11	20.0	23.2
12	22.0	25.2
13	24.0	27.2
14	26.0	29.2
15	28.0	31.2
16	30.0	33.2

COLOR CODE	
BLANK	NATURAL
A	BLACK
C	RED
D	ORANGE
E	YELLOW
G	BLUE



TOLERANCE		PART NO.		朝貴電子股份有限公司 CKM ELECTRONICS CO., LTD.	
X.	X.XXX ±0.10	2002HV-XP-X-HF		DESCRIPTION	
X.X	±0.40	DRAWING NO.		2.0mm PITCH CRIMP TERMINAL SOCKET (HV)	
X.XX	±0.30	C- 20020101-XX		APPROVED BY	
		UNIT: mm		CHECKED BY	
DWG TYPE.		Ivan Su 2021.08.03		DRAWN BY	
Customer Drawing		Lance Cheng 2021.08.03		Jimmy Wang 2021.08.03	
				PAGE	
				1 OF 2	
				SCALE	
				5 : 1	
				REV.	
				C	

C	EC-21080961	ADD COLOR OPTION	Jimmy Wang	2021.08.03
B		UPDATE DRAWING	WINNER	2017.03.24
REV.	ECN NO	REVISION RECORD	DRAW	DATE

RoHS

HF

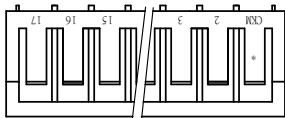

PRODUCT

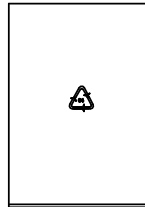

PE BAG: 1000 PCS

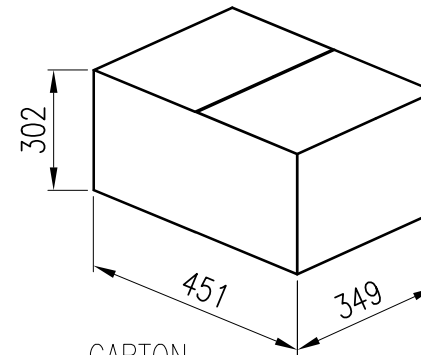
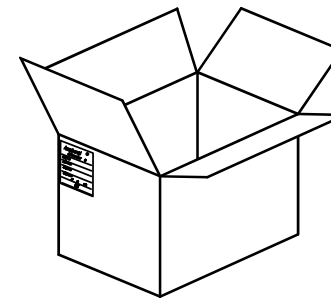

CARTON



POS	PCS / PE BAG	PCS / CARTON
2	1000	260K
3		170K
4		140K
5		120K
6		90K
7		80K
8		80K
9		65K
10		60K
11		45K
12		45K
13		40K
14		35K
15		35K
16		35K

TOLERANCE X. X.XXX ±0.10 X.X ±0.40 X.XX ±0.30 Angular ±2°		PART NO. 2002HV-XP-X-HF		朝貴電子股份有限公司 CKM ELECTRONICS CO., LTD.	
UNIT: mm DWG TYPE. Customer Drawing		DRAWING NO. C- 20020101-XX		DESCRIPTION 2.0mm PITCH CRIMP TERMINAL SOCKET (HV)	
APPROVED BY Ivan Su 2021.08.03		CHECKED BY Lance Cheng 2021.08.03		DRAWN BY Jimmy Wang 2021.08.03	
		PAGE 2 OF 2		REV. C	
		SCALE 5 : 1			

C	EC-21080961	ADD COLOR OPTION	Jimmy Wang	2021.08.03
B		UPDATE DRAWING	WINNER	2017.03.24
REV.	ECN NO	REVISION RECORD	DRAW	DATE