

RoHS

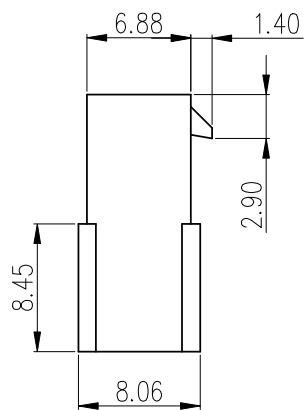
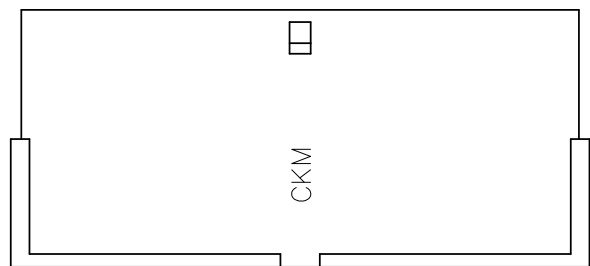
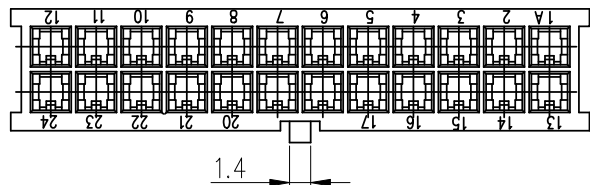
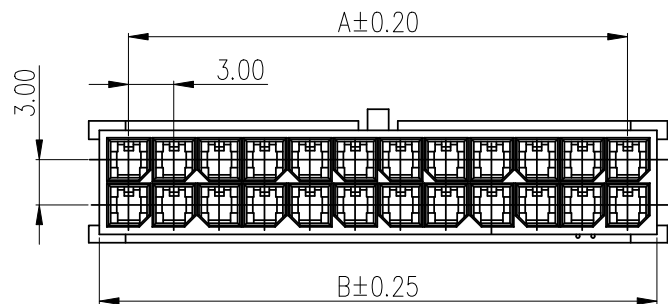

NOTE:

1. MATERIAL: NYLON 66, UL 94V-0 (BLACK)
2. RoHS & HALOGEN FREE COMPLIANCE
3. BILL OF PART NO.

30010102-2xXX

→CIRCUIT: 01~12

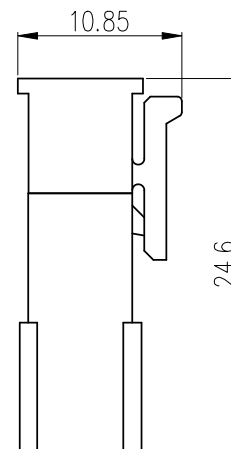

POS	A	B
02	--	3.90
04	3.0	6.90
06	6.0	9.90
08	9.0	12.90
10	12.0	15.90
12	15.0	18.90
14	18.0	21.90
16	21.0	24.90
18	24.0	27.90
20	27.0	30.90
22	30.0	33.90
24	33.0	36.90



MATED CONNECTORS

<b>TOLERANCE</b> X. X.X ±0.30 X.XX ±0.20 X.XXX ±0.10 Angular ±2°		<b>PART NO.</b> 30010102-2xXX		朝貴電子股份有限公司 CKM ELECTRONICS CO., LTD.	
UNIT: mm		<b>DRAWING NO.</b> C-30010102-2xXX		<b>DESCRIPTION</b> 3.0mm PITCH CRIMP TERMINAL SOCKET	
<b>DWG TYPE.</b> Customer Drawing		<b>APPROVED BY</b> Angus.Chen 2018.11.10	<b>CHECKED BY</b> Sun.Lee 2018.11.10	<b>DRAWN BY</b> Rock 2018.11.10	<b>PAGE</b> 1 OF 3 <b>SCALE</b> 2 : 1
				<b>REV.</b> A	

A		NEW RELEASE	Rock	2018.11.10
REV.	ECN NO	REVISION RECORD	DRAW	DATE

RoHS

HF

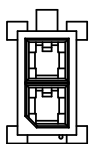

2x1P

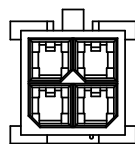

2x2P

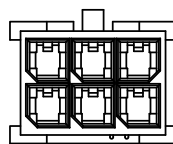

2x3P

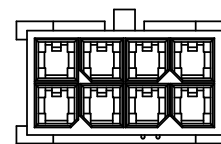

2x4P

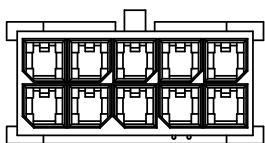

2x5P

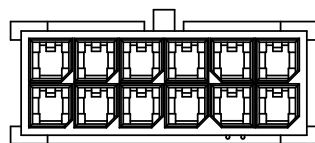

2x6P

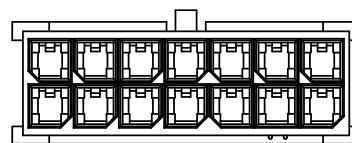

2x7P

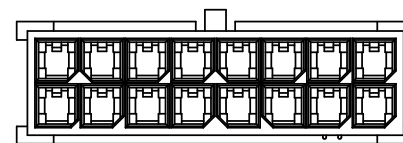

2x8P

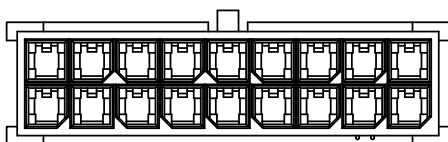

2x9P

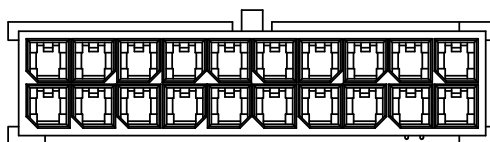

2x10P

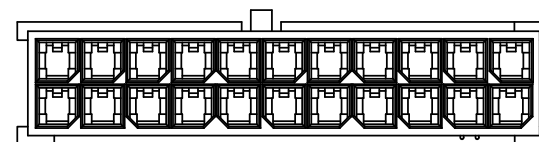

2x11P

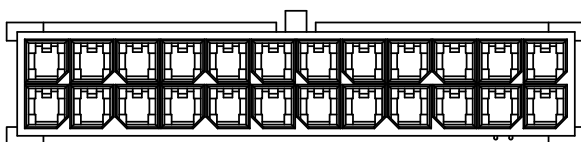

2x12P

CKM  
2018.11.14  
研发部

TOLERANCE		PART NO.		朝貴電子股份有限公司	
X.	X.XXX ±0.10	30010102-2xXX		CKM ELECTRONICS CO., LTD.	
X.X ±0.30	Angular ±2°	DRAWING NO.		DESCRIPTION	
X.XX ±0.20		C-30010102-2xXX		3.0mm PITCH CRIMP TERMINAL SOCKET	
UNIT: mm		APPROVED BY	CHECKED BY	DRAWN BY	PAGE
DWG TYPE.		Angus.Chen	Sun.Lee	Rock	2 OF 3
Customer Drawing		2018.11.10	2018.11.10	2018.11.10	SCALE
					2 : 1
					REV. A

A		NEW RELEASE	Rock	2018.11.10
REV.	ECN NO	REVISION RECORD	DRAW	DATE

RoHS

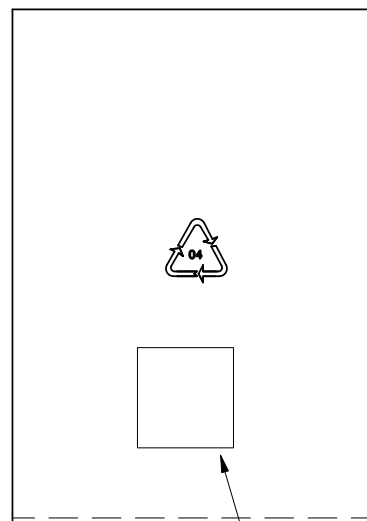
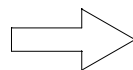
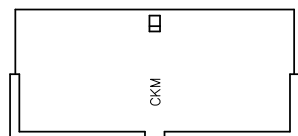

LABEL

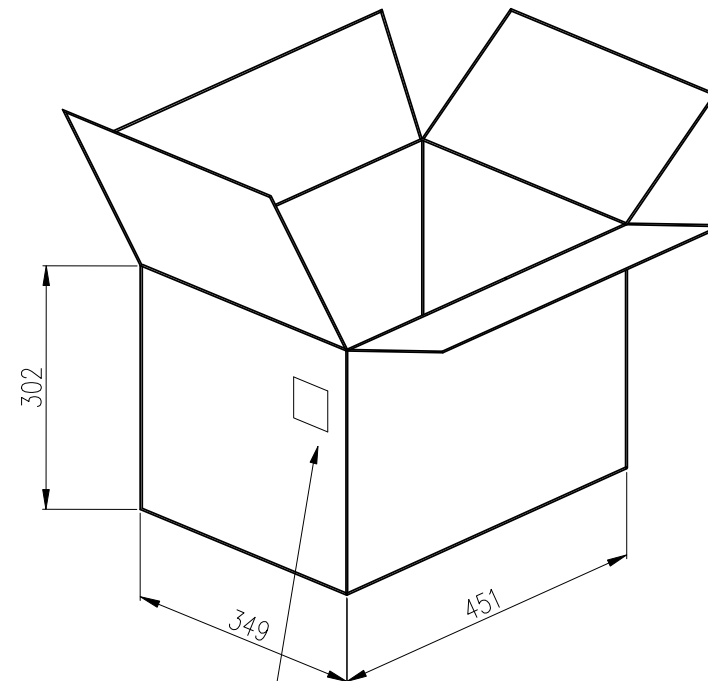
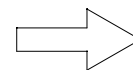

LABEL

POS	PCS/PE BAG	PCS/CARTON	N.W/KG	G.W/KG
02	1000	10000	3.12	3.82
04	1000	10000	4.00	4.70
06	1000	10000	5.40	6.10
08	800	8000	5.44	6.14
10	800	8000	6.54	7.26
12	800	8000	7.68	8.38
14	800	8000	8.80	9.50
16	600	6000	7.74	8.44
18	600	6000	8.88	9.58
20	600	6000	9.30	10.00
22	500	5000	8.05	8.75
24	500	5000	8.65	9.35

<b>TOLERANCE</b> X. X.X ±0.30 X.XX ±0.20 X.XXX ±0.10 Angular ±2°		<b>PART NO.</b> 30010102-2xXX		朝貴電子股份有限公司 CKM ELECTRONICS CO., LTD.	
UNIT: mm		<b>DRAWING NO.</b> C-30010102-2xXX		<b>DESCRIPTION</b> 3.0mm PITCH CRIMP TERMINAL SOCKET	
<b>DWG TYPE.</b> Customer Drawing		<b>APPROVED BY</b> Angus.Chen 2018.11.10	<b>CHECKED BY</b> Sun.Lee 2018.11.10	<b>DRAWN BY</b> Rock 2018.11.10	PAGE 3 OF 3 SCALE 2 : 1
					REV. A

A		NEW RELEASE	Rock	2018.11.10
REV.	ECN NO	REVISION RECORD	DRAW	DATE