

RoHS

HF

CUST INFORMATION.

PART NO.	DRAWING NO.	REV.
----------	-------------	------

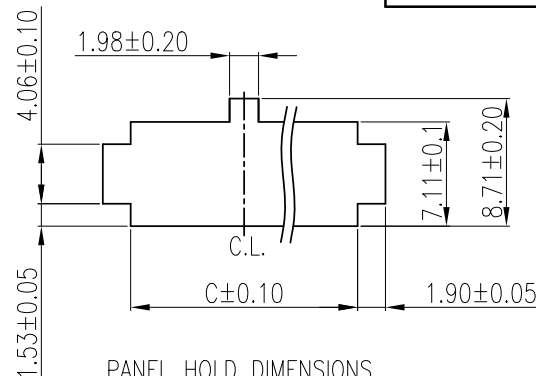
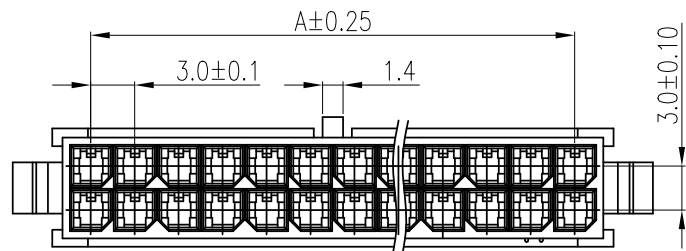

PANEL HOLD DIMENSIONS
THICKNESS: 2.00~2.60 mm

NOTE:

- MATERIAL: NYLON 66, UL 94V-0 (BLACK)
- RoHS & HALOGEN FREE COMPLIANCE
- BILL OF PART NO.
CKM30010102-2xXX-HK
CIRCUIT: 01~12

4. DIMENSIONAL:

POS	A	B	C
2x2	3.0	6.90	7.09

5. FOR CAVAILABILITY, DELIVERY & MOQ, CONTACT CKM

A

B

C

D

A

B

C

D

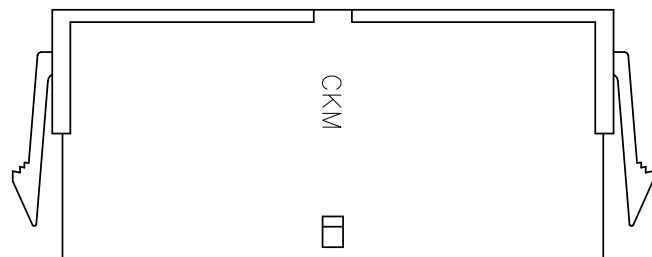
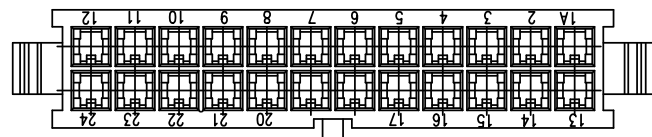
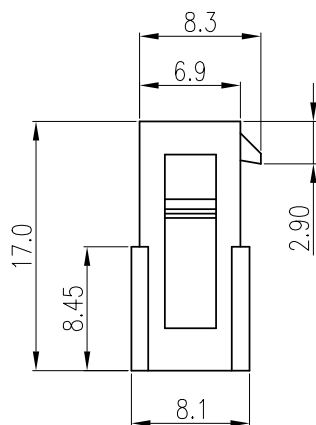
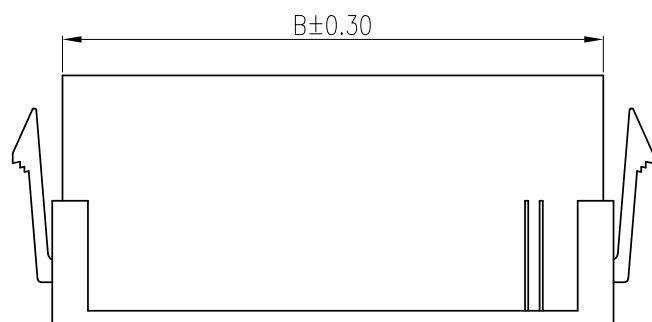

TOLERANCE		PART NO.		朝貴電子股份有限公司	
X. X.XXX ±0.10		CKM30010102-2xXX-HK		CKM ELECTRONICS CO., LTD.	
X.X ±0.30		DRAWING NO.		TITLE.	
X.XX ±0.20	Angular ±2°	C-CKM30010102-2xXX-HK		3.0mm PITCH CRIMP TERMINAL SOCKET	
		UNIT:	APPROVED BY	CHECKED BY	DRAWN BY
		mm	Ivan Su	Lance Cheng	Jimmy Wang
DWG TYPE.			SCALE	PAGE	REV.
Customer Drawing			2 : 1	1 OF 3	A

NEW RELEASE	Jimmy Wang	2021.12.09
REV.	ECN NO	REVISION RECORD
		DRAW
		DATE

1

2

3

4

5

6

QMI-P12-05-01

RoHS

HF

CUST INFORMATION.

PART NO.	DRAWING NO.	REV.
----------	-------------	------

CKM
2023.09.04
研发部

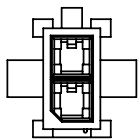

2x1P

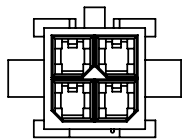

2x2P

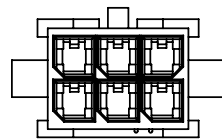

2x3P

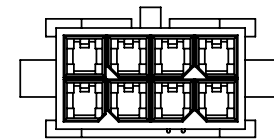

2x4P

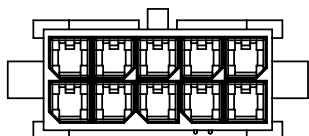

2x5P

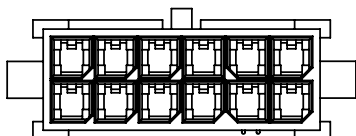

2x6P

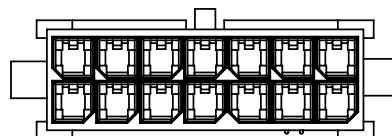

2x7P

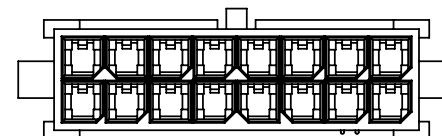

2x8P

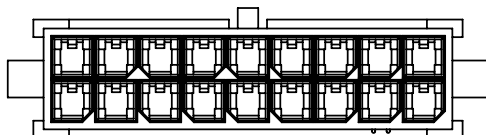

2x9P

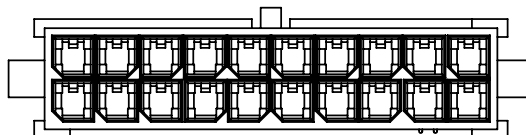

2x10P

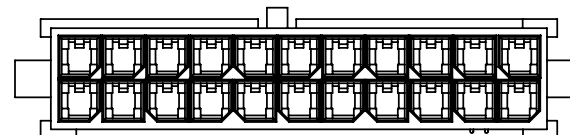

2x11P

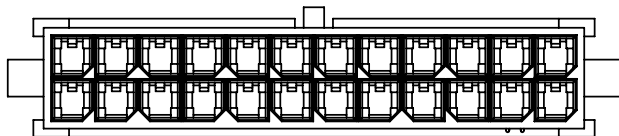

2x12P

TOLERANCE		PART NO.		朝貴電子股份有限公司 CKM ELECTRONICS CO., LTD.	
X.	X.XXX ±0.10	CKM30010102-2xXX-HK		TITLE.	
X.X ±0.30		DRAWING NO.		3.0mm PITCH CRIMP TERMINAL SOCKET	
X.XX ±0.20	Angular ±2°	C-CKM30010102-2xXX-HK		APPROVED BY	
		UNIT:		CHECKED BY	
	mm	Ivan Su		Lance Cheng	
DWG TYPE.		2021.12.09		DRAWN BY	
Customer Drawing		2021.12.09		Jimmy Wang	
		2021.12.09		PAGE	
		2021.12.09		2 OF 3	
				SCALE	
				2 : 1	
				REV.	
				A	

A		NEW RELEASE	Jimmy Wang	2021.12.09
REV.	ECN NO	REVISION RECORD	DRAW	DATE

1 RoHS



6 CUST INFORMATION.

PART NO.	DRAWING NO.	REV.
----------	-------------	------

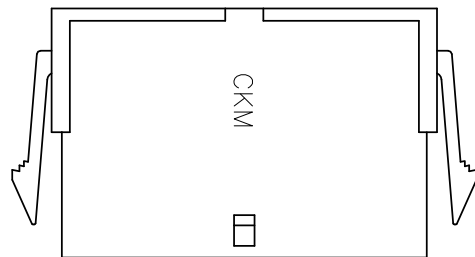

PRODUCTS

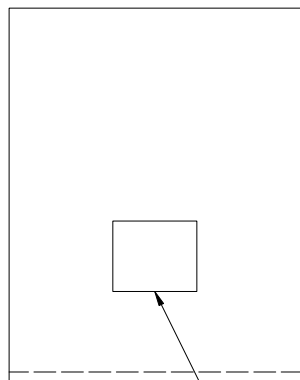
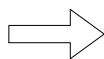

PE BAG

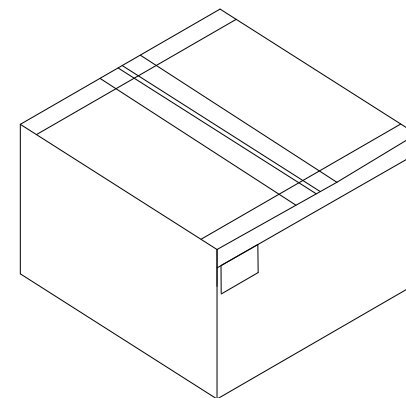
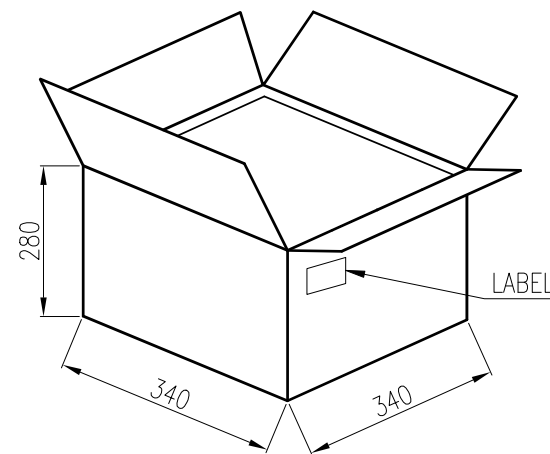

POS	PCS/PE BAG	PCS/CARTON	N.W/KG	G.W/KG
2x2	500	6000	3.84	4.60

TOLERANCE X. X.XXX ±0.10 X.X ±0.30 X.XX ±0.20 Angular ±2°		PART NO. CKM30010102-2xXX-HK		朝貴電子股份有限公司 CKM ELECTRONICS CO., LTD.	
		DRAWING NO. C-CKM30010102-2xXX-HK		TITLE. 3.0mm PITCH CRIMP TERMINAL SOCKET	
DWG TYPE. Customer Drawing		APPROVED BY Ivan Su 2021.12.09	CHECKED BY Lance Cheng 2021.12.09	DRAWN BY Jimmy Wang 2021.12.09	PAGE 3 OF 3 SCALE 2 : 1
					REV. A

A		NEW RELEASE	Jimmy Wang	2021.12.09
REV.	ECN NO	REVISION RECORD	DRAW	DATE