



1 RoHS



6 CUST INFORMATION.

PART NO. DRAWING NO. REV.

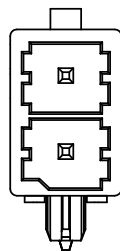

FOR 2P

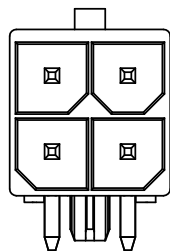

FOR 4P

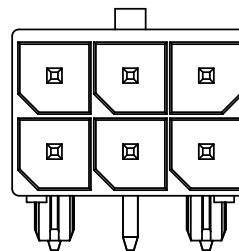

FOR 6P

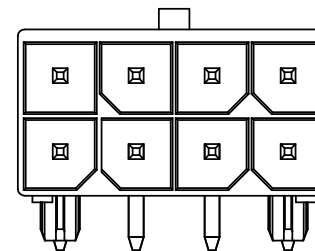

FOR 8P

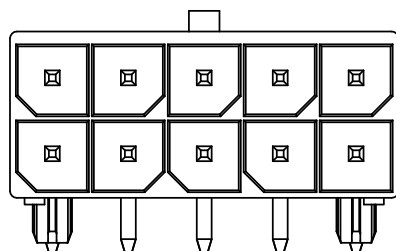

FOR 10P

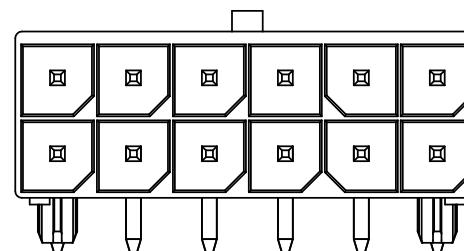

FOR 12P

|                  |             |                           |  |   |  |
|------------------|-------------|---------------------------|--|---|--|
| <b>TOLERANCE</b> |             | <b>PART NO.</b>           |  | 朝貴電子股份有限公司<br>CKM ELECTRONICS CO., LTD.   |  |
| X. X.XXX ±0.10   |             | 5701WR-XP-XX-X            |  | <b>TITLE.</b>                             |  |
| X.X ±0.30        |             | <b>DRAWING NO.</b>        |  | 5.7mm PITCH RIGHT ANGLE DIPTYPE CONNECTOR |  |
| X.XX ±0.20       | Angular ±2° | C-5701WR-XP-XX-X          |  | <b>APPROVED BY</b>                        |  |
|                  |             | UNIT: mm                  |  | <b>CHECKED BY</b>                         |  |
| <b>DWG TYPE.</b> |             | Ivan Su<br>2021.09.06     |  | <b>DRAWN BY</b>                           |  |
| Customer Drawing |             | Lance Cheng<br>2021.09.06 |  | Jimmy Wang<br>2021.09.06                  |  |
|                  |             | <b>PAGE</b>               |  | <b>REV.</b>                               |  |
|                  |             | 2 OF 3                    |  | A   |  |
|                  |             | <b>SCALE</b>              |  |   |  |
|                  |             | 2 : 1                     |  |   |  |

|      |        |                 |            |            |
|------|--------|-----------------|------------|------------|
| A    |        | NEW RELEASE     | Jimmy Wang | 2021.09.06 |
| REV. | ECN NO | REVISION RECORD | DRAW       | DATE       |

1 RoHS



2

3

4

5

6

CUST INFORMATION.

|          |             |      |
|----------|-------------|------|
| PART NO. | DRAWING NO. | REV. |
|----------|-------------|------|

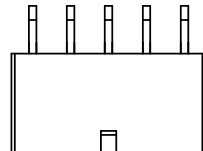

PRODUCTYS

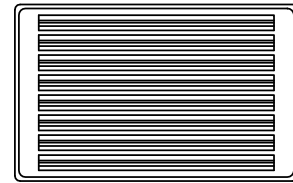

TRAY BOTTOM COVER

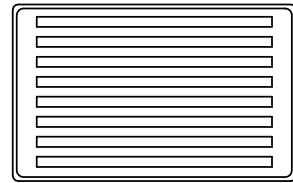

TRAY TOP COVER

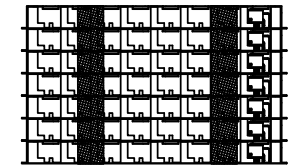

STACK 7 TRAYS TOGETHER

PE MEMBRANE



Stick by the label

CARTON

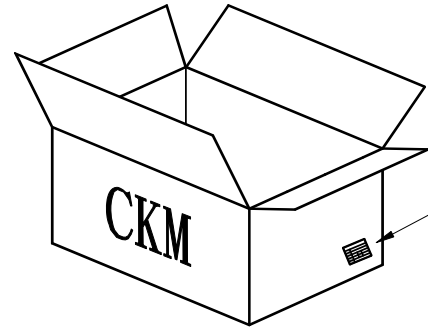
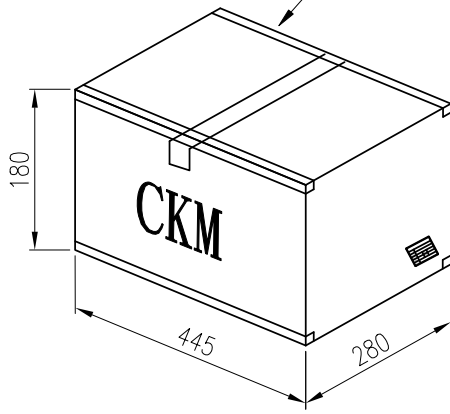

LABEL

| POS | PCS/TRAY | PCS/CARTON | N/W(kg) | G/W(kg) |
|-----|----------|------------|---------|---------|
| 2   | 336      | 2352       | 3.88    | 5.88    |
| 4   | 232      | 1624       | 4.40    | 6.40    |
| 6   | 152      | 1064       | 4.15    | 6.15    |
| 8   | 120      | 840        | 4.28    | 6.28    |
| 10  | 96       | 672        | 4.22    | 6.22    |
| 12  | 80       | 560        | 4.18    | 6.18    |

|  |  |   |  |  |  |
|--|--|---|--|--|--|
| <b>TOLERANCE</b><br>X. X.XXX ±0.10<br>X.X ±0.30<br>X.XX ±0.20<br>Angular ±2° |  | <b>PART NO.</b><br>5701WR-XP-XX-X           |  | 朝貴電子股份有限公司<br>CKM ELECTRONICS CO., LTD.                    |  |
|  |  | <b>DRAWING NO.</b><br>C-5701WR-XP-XX-X      |  | <b>TITLE.</b><br>5.7mm PITCH RIGHT ANGLE DIPTYPE CONNECTOR |  |
| <b>UNIT:</b><br>mm   |  | <b>APPROVED BY</b><br>Ivan Su<br>2021.09.06 | <b>CHECKED BY</b><br>Lance Cheng<br>2021.09.06 | <b>DRAWN BY</b><br>Jimmy Wang<br>2021.09.06                | <b>PAGE</b><br>3 OF 3<br><br><b>SCALE</b><br>2 : 1 |
| <b>DWG TYPE.</b><br>Customer Drawing   |  |   |  | <b>REV.</b><br>A   |  |

|      |        |                 |            |            |
|------|--------|-----------------|------------|------------|
| A    |        | NEW RELEASE     | Jimmy Wang | 2021.09.06 |
| REV. | ECN NO | REVISION RECORD | DRAW       | DATE       |

1

2

3

4

5

6 QMI-P12-05-01