

RoHS



CUST INFORMATION.

PART NO.	DRAWING NO.	REV.
----------	-------------	------

NOTE:

- 1.MATERIAL:NYLON 66,UL 94V-0.
- 2.RoHS & HALOGEN FREE COMPLIANCE.
- 3.BILL OF PART NO.

3001H-XP-X-XX-HF

No.OF POS:2~12

COLOR:  
BLANK=NATURAL  
A=BLACK

HC MARK:  
BLANK=STANDARD(W/O HC LOGO)  
HC=WITH HC LOGO.

4. FOR COLOR, AVAILABILITY, DELIVERY & MOQ, CONTACT CKM.

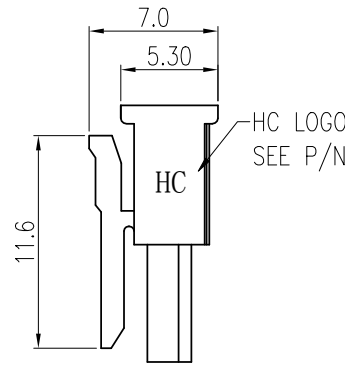
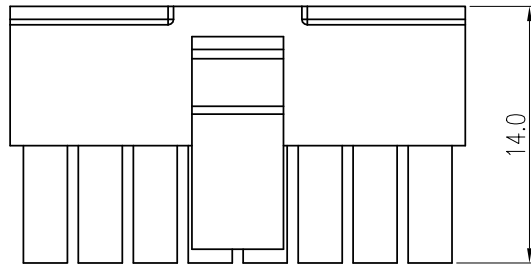

POS	A	B
2	3.00	6.85
3	6.00	9.85
4	9.00	12.85
5	12.00	15.85
6	15.00	18.85
7	18.00	21.85
8	21.00	24.85
9	24.00	27.85
10	27.00	30.85
11	30.00	33.85
12	33.00	36.85

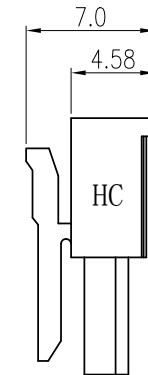
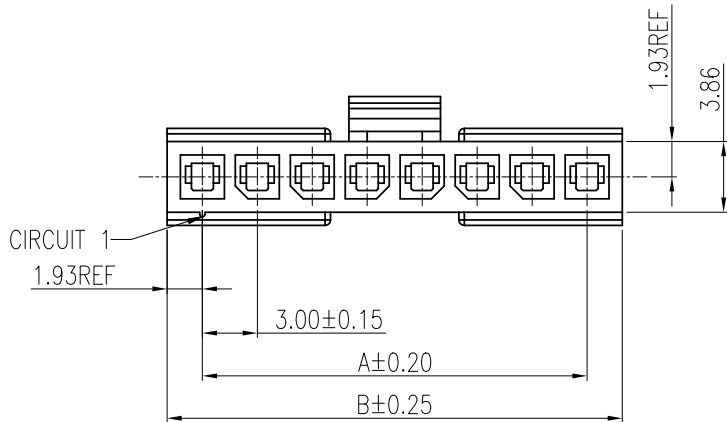

FOR 2~4 POS

<b>TOLERANCE</b>		<b>PART NO.</b>		朝貴電子股份有限公司 CKM ELECTRONICS CO., LTD.		
X. ±0.50	X.XXX ±0.15	3001H-XP-X-XX-HF				
X.X ±0.35		<b>DRAWING NO.</b>		TITLE: MINITEK PWR3.0 WIRE CONNECTOR RECEPTACLE HSG SINGLE ROW		
X.XX ±0.25	Angular ±5°	C-3001H-XP-X-XX-HF				
UNIT: mm		<b>APPROVED BY</b>	<b>CHECKED BY</b>	<b>DRAWN BY</b>	<b>PAGE</b>	<b>REV.</b>
		Angus.Chen	Sun.Lee	Rock	10F3	
<b>DWG TYPE.</b>		<b>SCALE</b>				
Customer Drawing		2.5 : 1				

NEW RELEASE	Rock	2023.07.19		
<b>REV.</b>	<b>ECN NO</b>	<b>REVISION RECORD</b>	<b>DRAW</b>	<b>DATE</b>

RoHS



CUST INFORMATION.

PART NO.	DRAWING NO.	REV.
----------	-------------	------

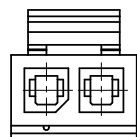

2 POS

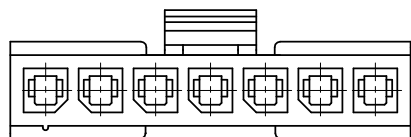

7 POS

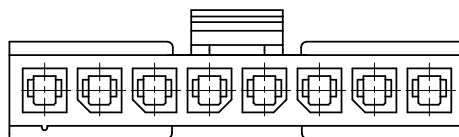

8 POS

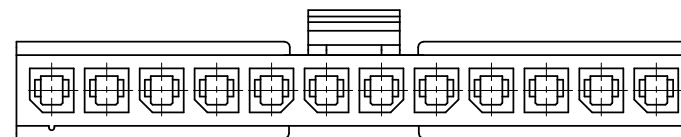

12 POS

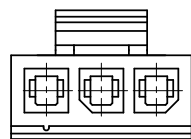

3 POS

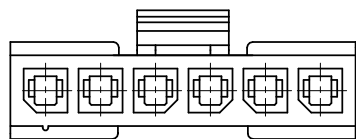

6 POS

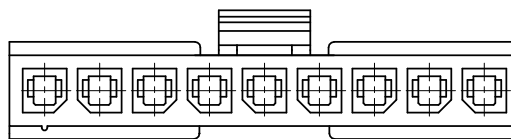

9 POS

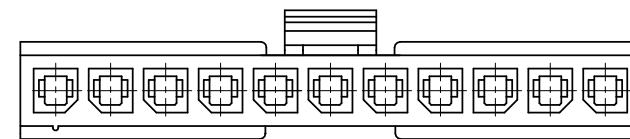

11 POS

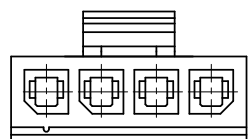

4 POS

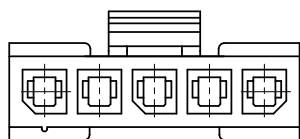

5 POS

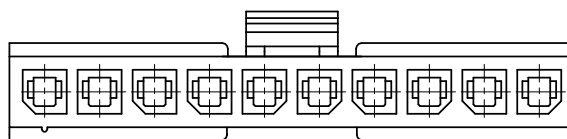

10 POS



<b>TOLERANCE</b>		PART NO. 3001H-XP-X-XX-HF		朝貴電子股份有限公司 <b>CKM ELECTRONICS CO., LTD.</b>	
X. ±0.50	X.XXX ±0.15	DRAWING NO. C-3001H-XP-X-XX-HF			
X.X ±0.35		UNIT: mm		APPROVED BY Angus.Chen 2023.07.19	CHECKED BY Sun.Lee 2023.07.19
X.XX ±0.25	Angular ±5°			DRAWN BY Rock 2023.07.19	
Dwg TYPE. Customer Drawing				SCALE 2.5 : 1	

REV.	ECN NO	REVISION RECORD	DRAW	DATE
A		NEW RELEASE	Rock	2023.07.19

1 RoHS



6 CUST INFORMATION.

PART NO. DRAWING NO. REV.

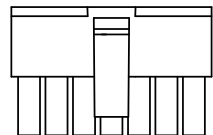

PRODUCTS

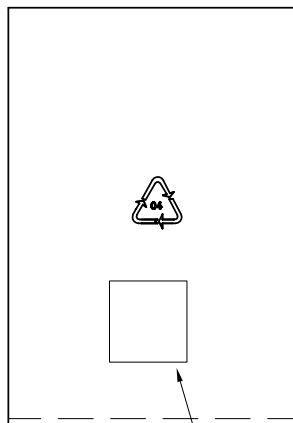
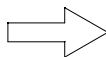

LABEL

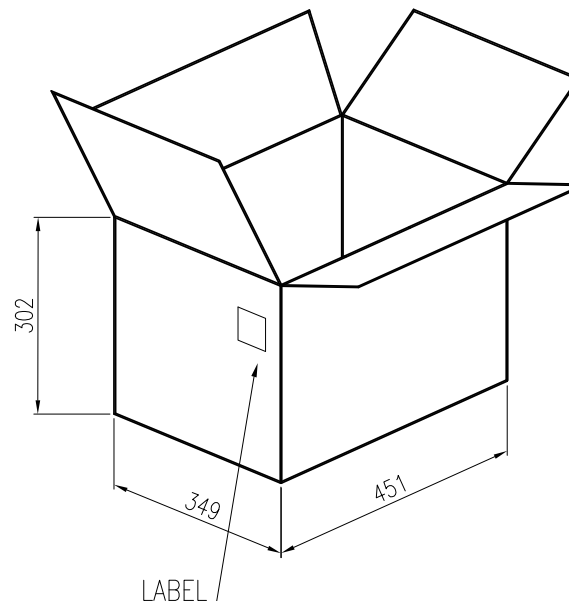
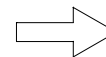

LABEL

POS	PCS/PE BAG	PCS/CARTON	N.W/KG	G.W/KG
2	1500	15000	4.05	4.65
3	1500	15000	5.18	5.78
4	1500	15000	6.30	6.90
5	1500	15000	7.43	8.03
6	1500	15000	8.55	9.15
7	1500	15000	9.68	10.28
8	1500	15000	10.80	11.40
9	1000	10000	7.95	8.55
10	1000	10000	8.70	9.30
11	1000	10000	9.45	10.05
12	1000	10000	10.20	10.08

<b>TOLERANCE</b>		<b>PART NO.</b>		朝貴電子股份有限公司	
X. ±0.50	X.XXX ±0.15	3001H-XP-X-XX-HF		CKM ELECTRONICS CO., LTD.	
X.X ±0.35		<b>DRAWING NO.</b>		<b>TITLE.</b> MINITEK PWR3.0 WIRE CONNECTOR	
X.XX ±0.25	Angular ±5°	C-3001H-XP-X-XX-HF		RECEPTACLE HSG SINGLE ROW	
		<b>UNIT:</b>		<b>APPROVED BY</b>	
		mm		Angus.Chen	
<b>DWG TYPE.</b>		<b>CHECKED BY</b>		<b>DRAWN BY</b>	
Customer Drawing		Sun.Lee		Rock	
		2023.07.19		2023.07.19	
				<b>PAGE</b>	
				30F3	
				<b>SCALE</b>	
				2.5 : 1	
				<b>REV.</b>	
				A	

A		NEW RELEASE	Rock	2023.07.19
<b>REV.</b>	<b>ECN NO</b>	<b>REVISION RECORD</b>	<b>DRAW</b>	<b>DATE</b>