

RoHS

HF

NOTE:

1. MATERIAL: NYLON 66 UL94 V-0.

2. RoHS & HF COMPLIANCE.

3. BILL OF PART NO:

3001H-2xXP-X-XX-HF

No OF POS:1~12

LOGO:

COLOR:

BLANK=W/O HC LOGO

BLANK=NATURAL

HC=W/ HC LOGO

A=BLACK

4. FOR COLOR, AVAILABILITY, DELIVERY & MOQ, CONTACT CKM.

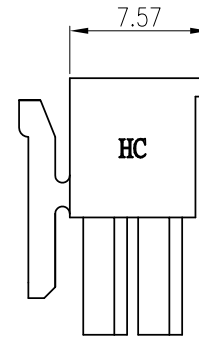
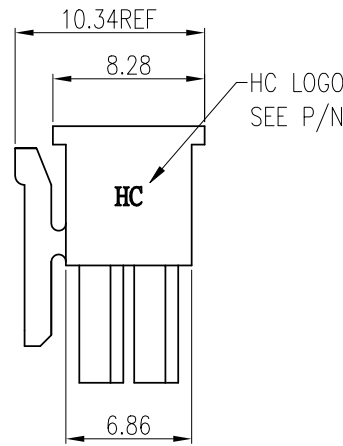
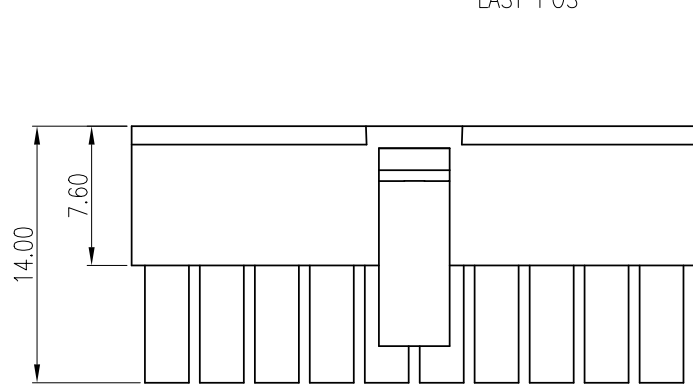
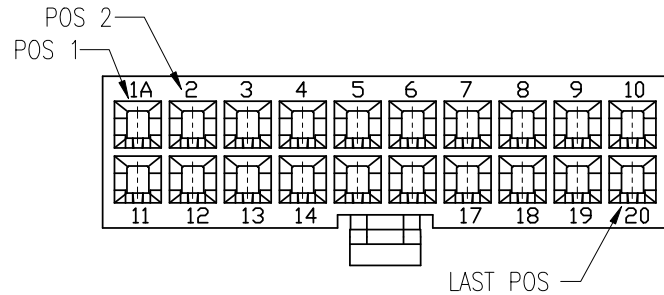

ONLY FOR 2PIN

POS	A	B
2x1		3.85
2x2	3.00	6.85
2x3	6.00	9.85
2x4	9.00	12.85
2x5	12.00	15.85
2x6	15.00	18.85
2x7	18.00	21.85
2x8	21.00	24.85
2x9	24.00	27.85
2x10	27.00	30.85
2x11	30.00	33.85
2x12	33.00	36.85

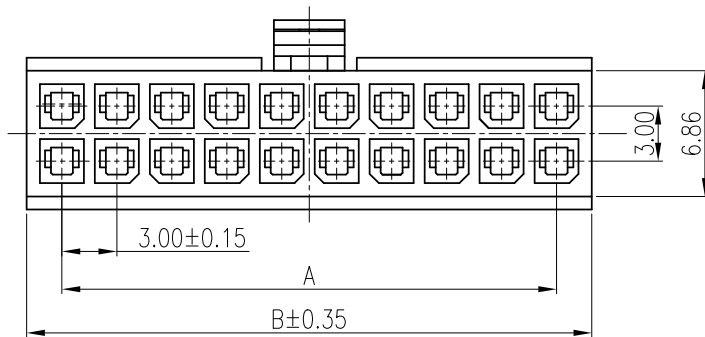

TOLERANCE		PART NO.	朝貴電子股份有限公司 CKM ELECTRONICS CO., LTD.	
X. ±0.50	X.XXX ±0.15	3001H-2xXP-X-XX-HF	TITLE: 3.0mm PITCH PLUG HOUSING, DUAL ROW	
X.X ±0.35	Angular ±5°	DRAWING NO. C-3001H-2xXP-X-XX-HF		
X.XX ±0.25		APPROVED BY Angus.Chen 2023.07.07	CHECKED BY Sun.Lee 2023.07.07	DRAWN BY Rock 2023.07.07
UNIT: mm		PAGE 10F3	SCALE 2.5 : 1	REV. A
DWG TYPE. Customer Drawing				

REV.	ECN NO	REVISION RECORD	DRAW	DATE
A		NEW RELEASE	Rock	2023.07.07

RoHS

HF

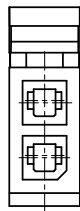

2\*1P

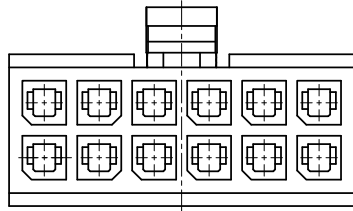

2\*6P

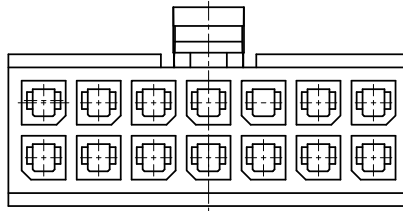

2\*7P

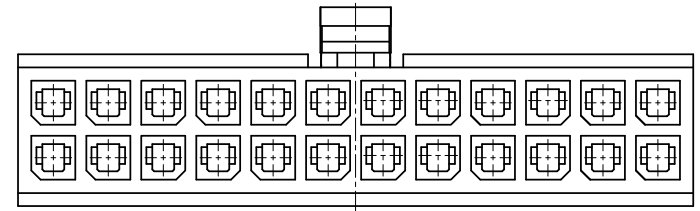

2\*12P

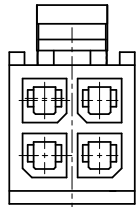

2\*2P

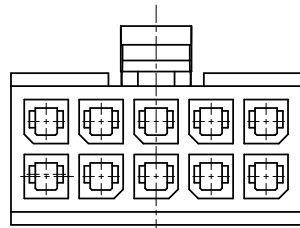

2\*5P

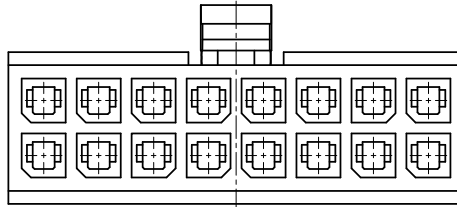

2\*8P

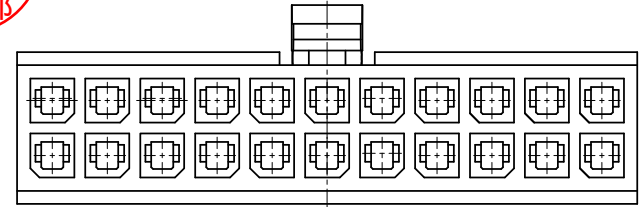

2\*11P

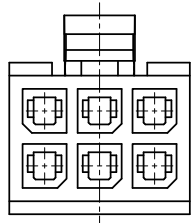

2\*3P

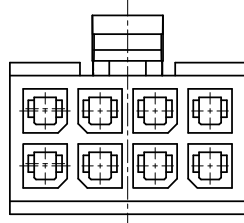

2\*4P

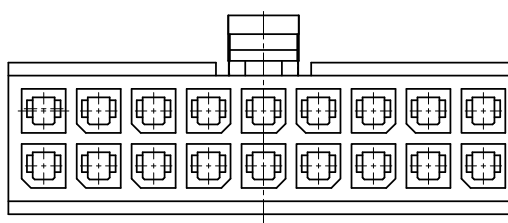

2\*9P

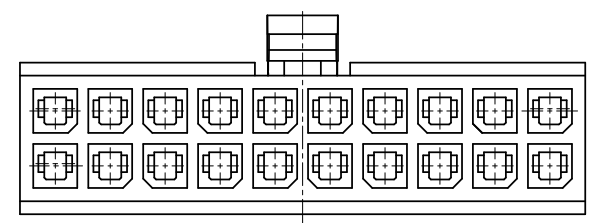

2\*10P

CKM  
2023.07.10  
研发部

TOLERANCE	
X. ±0.50	X.XXX ±0.15
X.X ±0.35	
X.XX ±0.25	Angular ±5°
UNIT: mm	
DWG TYPE: Customer Drawing	

PART NO. 3001H-2xXP-X-XX-HF	DRAWING NO. C-3001H-2xXP-X-XX-HF
APPROVED BY Angus.Chen 2023.07.07	CHECKED BY Sun.Lee 2023.07.07

朝貴電子股份有限公司 CKM ELECTRONICS CO., LTD.	
TITLE: 3.0mm PITCH PLUG HOUSING, DUAL ROW	
DRAWN BY Rock 2023.07.07	PAGE 20F3
SCALE 2.5 : 1	REV. A

A	NEW RELEASE	Rock	2023.07.07
REV.	ECN NO	REVISION RECORD	DRAW DATE

RoHS

HF

CKM  
2023.07.10  
研发部

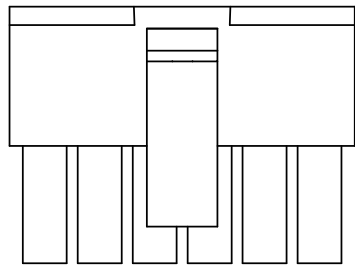

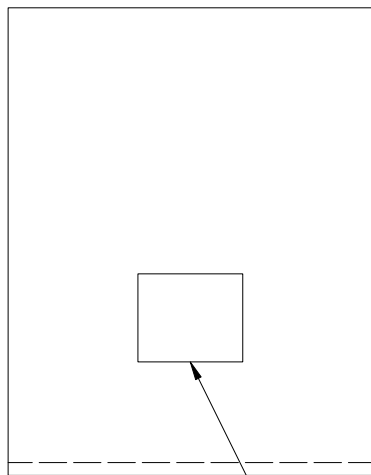
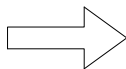

PRODUCTS

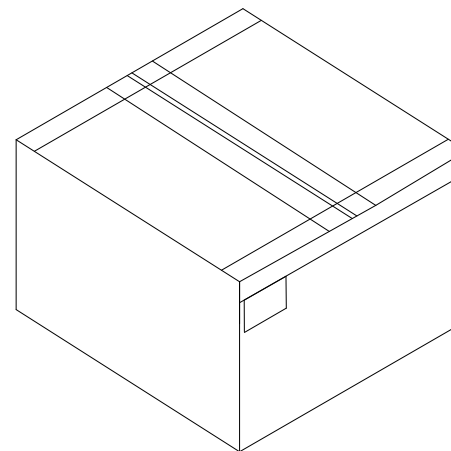
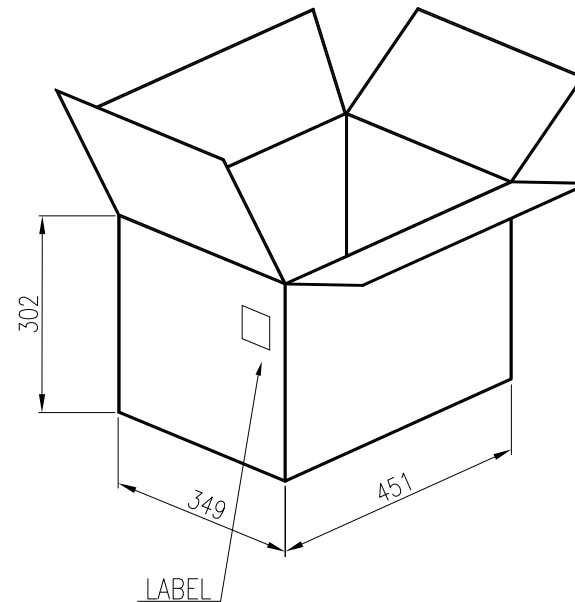
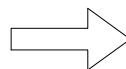

PE BAG



POS	PCS/PE BAG	PCS/CARTON	N.W/KG	G.W/KG
2x1	1000	10000	3.12	3.82
2x2	1000	10000	4.00	4.70
2x3	1000	10000	5.40	6.10
2x4	800	8000	5.44	6.14
2x5	800	8000	6.54	7.26
2x6	800	8000	7.68	8.38
2x7	800	8000	8.80	9.50
2x8	600	6000	7.74	8.44
2x9	600	6000	8.88	9.58
2x10	600	6000	9.30	10.00
2x11	500	5000	8.05	8.75
2x12	500	5000	8.65	9.35

<b>TOLERANCE</b>		<b>PART NO.</b>		 朝貴電子股份有限公司 CKM ELECTRONICS CO., LTD.	
X. ±0.50	X.XXX ±0.15	3001H-2xXP-X-XX-HF			
X.X ±0.35	Angular ±5°	<b>DRAWING NO.</b>		TITLE: 3.0mm PITCH PLUG HOUSING, DUAL ROW	
X.XX ±0.25		C-3001H-2xXP-X-XX-HF			
 	<b>UNIT:</b>	<b>APPROVED BY</b>	<b>CHECKED BY</b>	<b>DRAWN BY</b>	<b>PAGE</b>
	mm	Angus.Chen	Sun.Lee	Rock	30F3
<b>DWG TYPE.</b>		2023.07.07	2023.07.07	2023.07.07	<b>SCALE</b>
Customer Drawing					2.5 : 1
					<b>REV.</b>
					A

A		NEW RELEASE	Rock	2023.07.07
<b>REV.</b>	<b>ECN NO</b>	<b>REVISION RECORD</b>	<b>DRAW</b>	<b>DATE</b>