

RoHS

CUST INFORMATION.

PART NO. NA	DRAWING NO. NA	REV. NA
----------------	-------------------	------------

NOTE:

- HOUSING MATERIAL: THERMOPLASTIC UL94V-0
- RoHS COMPLIANT.
- BILL OF PART NO:

NO	PART NO	COLOR	LOGO
1	20080101-XX	NATURAL	CKM
2	20080102-XX	BLACK	CKM

4. DIMENSIONAL ORDERING INFORMATION :

34.0	32.5	30.0	32
32.0	30.5	28.0	30
30.0	28.5	26.0	28
28.0	26.5	24.0	26
26.0	24.5	22.0	24
24.0	22.5	20.0	22
22.0	20.5	18.0	20
20.0	18.5	16.0	18
18.0	16.5	14.0	16
16.0	14.5	12.0	14
14.0	12.5	10.0	12
12.0	10.5	8.0	10
10.0	8.5	6.0	08
8.0	6.5	4.0	06
6.0	4.5	2.0	04
C	B	A	POS

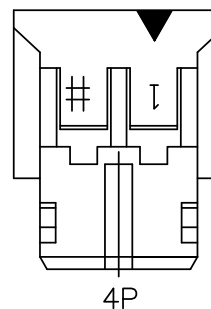
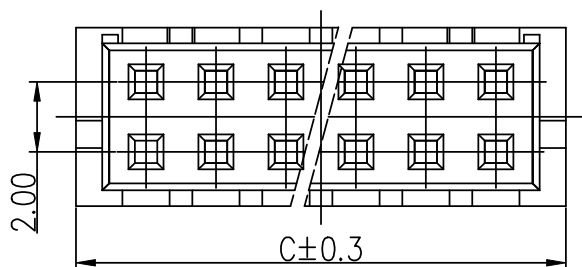
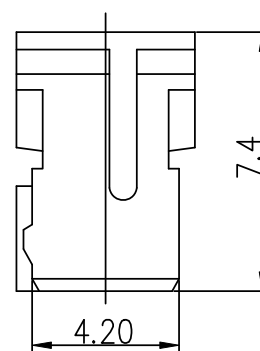
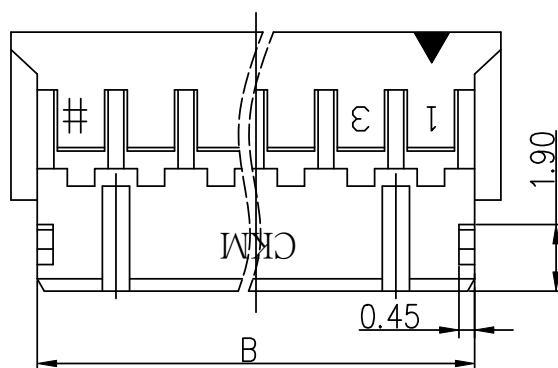
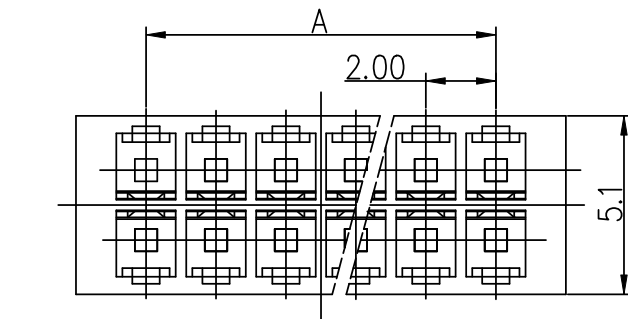

TOLERANCE		PART NO.		朝貴電子股份有限公司 CKM ELECTRONICS CO., LTD.		
X.	X.XXX ±0.10	2008010X-XX				
X.X ±0.30		DRAWING NO.		TITLE: 2.0mm PITCH HOUSING(2008)		
X.XX ±0.20	Angular ±2°	C-2008010X-XX				
UNIT: mm DWG TYPE. Customer Drawing		APPROVED BY	CHECKED BY	DRAWN BY	PAGE 1 OF 2	REV. B
					SCALE 5 : 1	

B		ADD PACKING DRAWING	Winner	2017.01.17
A		NEW RELEASE	Winner	2013.11.25
REV.	ECN NO	REVISION RECORD	DRAW	DATE

1
RoHS

2
HF

6
CUST INFORMATION.

PART NO.	DRAWING NO.	REV.
----------	-------------	------

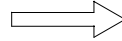

3
PE BAG : XXX PCS

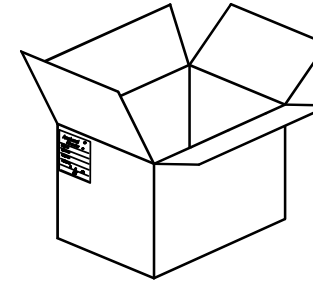
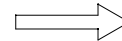
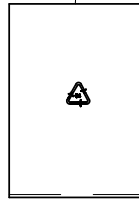

CARTON : XXXX PCS

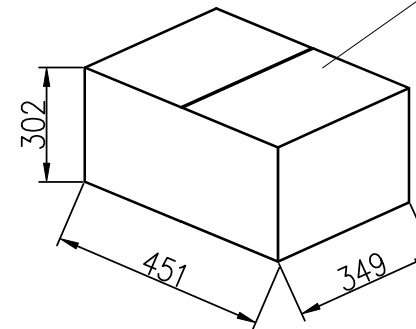

POS	PCS/PE BAG	PCS/CARTON	GROSS WEIGHT	NET WEIGHT
6	1000	80000	9.7 Kg	8.8 Kg
8	1000	70000	10.0 Kg	9.1 Kg
10	1000	60000	10.5 Kg	9.6 Kg
12	1000	50000	10.4 Kg	9.5Kg
14	1000	40000	9.7 Kg	8.8 Kg
16	1000	35000	9.65 Kg	8.75 Kg
18	1000	30000	9.0 Kg	8.1 Kg
20	1000	30000	9.9 Kg	9.0 Kg
22	1000	25000	9.15 Kg	8.25Kg
24	1000	25000	9.65 Kg	8.75 Kg
26	1000	20000	8.7 Kg	7.8 Kg
28	1000	20000	9.1 Kg	8.2 Kg
30	1000	18000	8.82 Kg	7.92Kg
32	1000	18000	9.36 Kg	8.46 Kg

CKM
2017.01.19
研發部

TOLERANCE		PART NO.		朝貴電子股份有限公司	
X.	X.XXX ±0.10	2008010X-XX		CKM ELECTRONICS CO., LTD.	
X.X	±0.30	DRAWING NO.		TITLE.	
X.XX	±0.20	C-2008010X-XX		2.0mm PITCH HOUSING(2008)	
UNIT: mm		APPROVED BY	CHECKED BY	DRAWN BY	PAGE
DWG TYPE.					20F2
Customer Drawing					SCALE
					1:1
					REV.
					B

B		NEW RELEASE		2017.01.17
REV.	ECN NO	REVISION RECORD	DRAW	DATE