

RoHS

HF

CUST INFORMATION.

PART NO.	DRAWING NO.	REV.
----------	-------------	------

NOTE:

- MATERIAL:
 - INSULATION: NYLON 6T, UL 94V-0
 - CONTACT=SQ. 0.50mm BRASS
- FINISH: TIN/GOLD PLATING
- BILL OF PART NO:

2008WS-XX-X X-HK-XX-XX-HF
 No OF CIRCS:06~40
 FINISH: A=MATTE TIN PLATED B=BRIGHT TIN PLATED
 HF=HALOGEN FREE
 M1=VIOD PIN 10TH
 M10=VIOD PIN 5,6,7,8TH
 Z6=VIOD PIN 17,18TH
 R=VIOD PIN 3,4TH
 DIM"D": BLANK(STANDARD=3.0) OR 2.1~3.5

COLOR: A(NATURAL) OR B THRU U

- FOR FINISH, COLOR, AVAILABILITY, DELIVERY & MOQ, CONTACT CKM
- DIMENSIONAL

POS	A	B	C
06	4.0	10.0	6.7
08	6.0	12.0	8.7
10	8.0	14.0	10.7
12	10.0	16.0	12.7
14	12.0	18.0	14.7
16	14.0	20.0	16.7
18	16.0	22.0	18.7
20	18.0	24.0	20.7
22	20.0	26.0	22.7
24	22.0	28.0	24.7
26	24.0	30.0	26.7
28	26.0	32.0	28.7
30	28.0	34.0	30.7
32	30.0	36.0	32.7
34	32.0	38.0	34.7
36	34.0	40.0	36.7
38	36.0	42.0	38.7
40	38.0	44.0	40.7

D
2.1
2.3
2.6
2.85
3.0
3.15
3.2
3.5

COLOR CODE	
A	NATURAL
B	BROWN
C	RED
D	ORANGE
E	YELLOW
F	GREEN
G	BLUE
H	PURPLE
J	GREY
K	WHITE
L	BLACK
M	MILKY YELLOW
Q	BRICK RED
U	MILKY WHITE

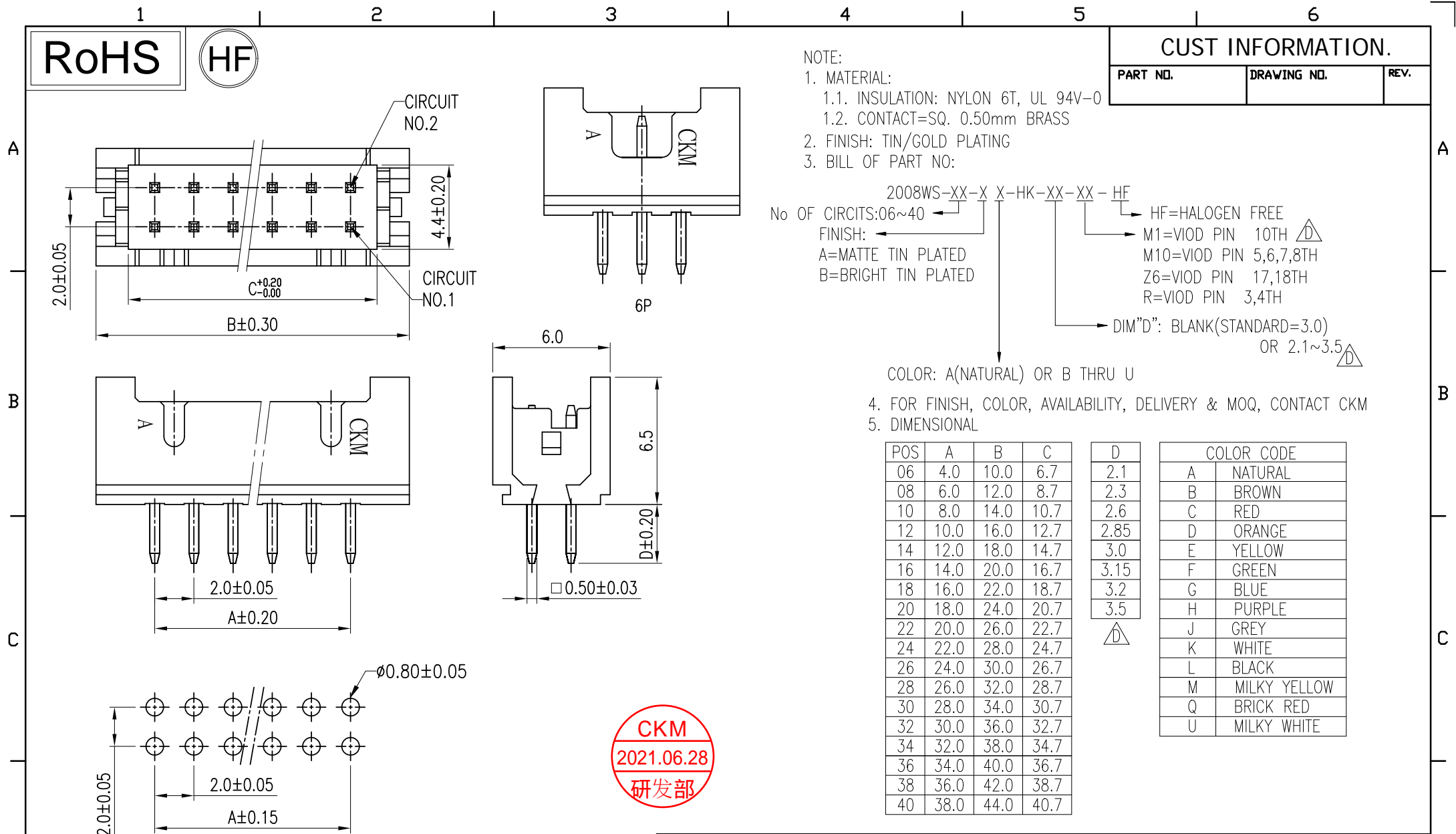

RECOMMENDED PCB LAYOUT (PCB THICK=1.6)

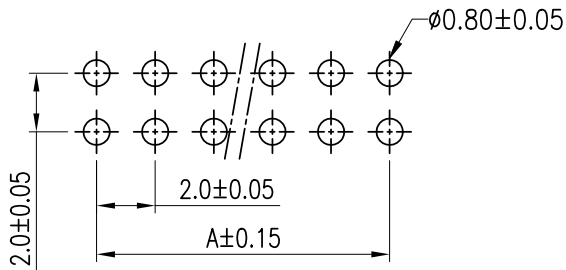

TOLERANCE

X.	±0.50	X.XXX	±0.15
X.X	±0.35		
X.XX	±0.25	Angular	±5°

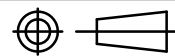

UNIT: mm

DWG TYPE: Customer Drawing

PART NO.

2008WS-XX-XX-HK-XX-XX-HF

DRAWING NO.

C-2008WS-XX-XX-HK-XX-XX-HF

APPROVED BY

Ivan_Su 2021/6/28

CHECKED BY

Deliang Li 2021/6/28

朝貴電子股份有限公司
 CKM ELECTRONICS CO., LTD.

TITLE: 2.0mm PITCH VERTICAL DIP TYPE CONNECTOR

DRAWN BY

Heimer 2021/6/28

PAGE

10F2

SCALE

1 : 1

REV.

D

D	EC-21070941	ADD NO M1,M10,Z6,R	Heimer	2021.6.28
C		UPDATE DRAWING	Winner	2017.07.03
REV.	ECN NO	REVISION RECORD	DRAW	DATE

1 RoHS



6 CUST INFORMATION.

PART NO.	DRAWING NO.	REV.
----------	-------------	------

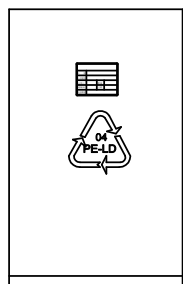

178x267
BAG

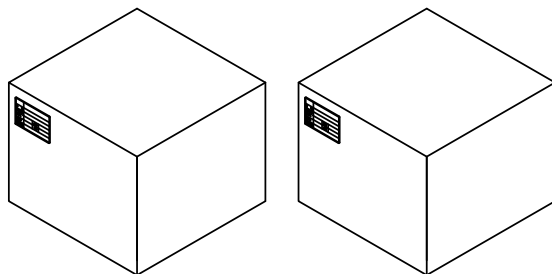

320x220x155
2 INNER BOX

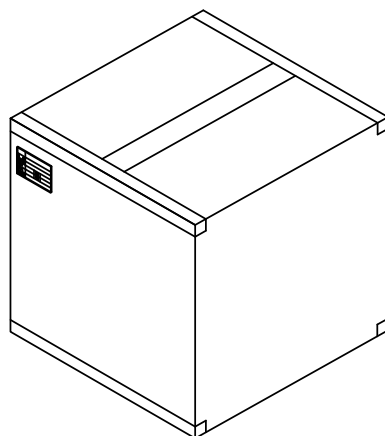

470x340x178
CARTON



POS	BAG	INNER BOX	CARTON
	PCS/BAG	PCS/BOX	PCS/CARTON
06	1000	8000	16000
08	1000	7000	14000
10	1000	7000	14000
12	1000	6000	12000
14	1000	6000	12000
16	500	5000	10000
18	500	5000	10000
20	500	4000	8000
22	500	4000	8000
24	500	3500	7000
26	500	3000	6000
28	500	3000	6000
30	500	3000	6000
32	500	2500	5000
34	500	2500	5000
36	400	2000	4000
38	400	2000	4000
40	400	1600	3200

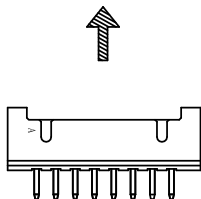

TOLERANCE	
X. ±0.50	X.XXX ±0.15
X.X ±0.35	
X.XX ±0.25	Angular ±5°
	UNIT: mm
DWG TYPE. Customer Drawing	

PART NO. 2008WS-XX-XX-HK-XX-XX-HF	
DRAWING NO. C-2008WS-XX-XX-HK-XX-XX-HF	
APPROVED BY Ivan_Su 2021/6/28	CHECKED BY Deliang Li 2021/6/28

	朝貴電子股份有限公司 CKM ELECTRONICS CO., LTD.
TITLE. 2.0mm PITCH VERTICAL DIP TYPE CONNECTOR	

D	EC-21070941	ADD NO M1,M10,Z6,R	Heimer	2021.6.28
C		UPDATE DRAWING	Winner	2017.07.03
REV.	ECN NO	REVISION RECORD	DRAW	DATE

DRAWN BY Heimer 2021/6/28	PAGE 20F2	REV. D
SCALE 1 : 1		

1 2 3 4 5 6

A

B

C

D

A

B

C

D