

RoHS



NOTE:

- 1. MATERIAL: NYLON 66 UL94 V-0.
- 2. RoHS & HF COMPLIANCE
- 3. BILL OF PART NO.

1503H-XP-X-HF
 No OF CIRCITS:2~15
 HF=HALOGEN FREE
 COLOR:BLANK(NATURAL)
 A:BLACK
 4. FOR COLOR, AVAILABILITY, DELIVERY & MOQ, CONTACT CKM

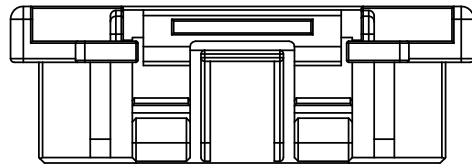

12Pin~15P
2 LOCK

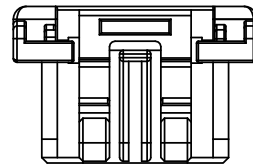

6Pin~11P
2 LOCK

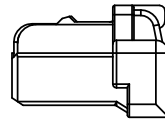
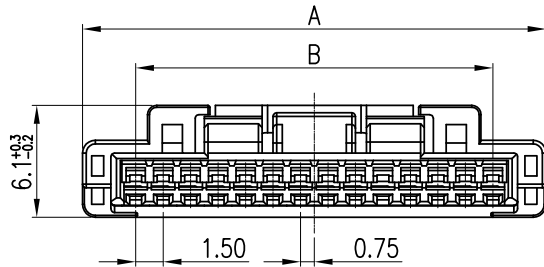

12Pin~15Pin

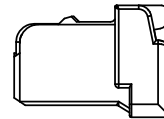

2Pin~11Pin

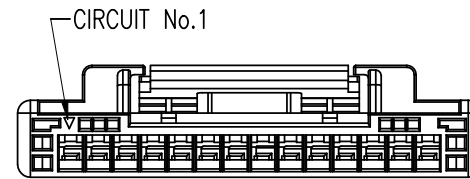

Pos.	A	B	C
2	7.30	—	4.20
3	8.80	3.00	5.70
4	10.30	4.50	7.20
5	11.80	6.00	8.70
6	13.30	7.50	10.20
7	14.80	9.00	11.70
8	16.30	10.50	13.20
9	17.80	12.00	14.70
10	19.30	13.50	16.20
11	20.80	15.00	17.70
12	22.30	16.50	19.20
13	23.80	18.00	20.70
14	25.30	19.50	22.20
15	26.80	21.00	23.70

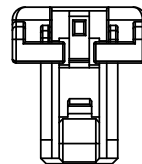

2PIN
1 LOCK

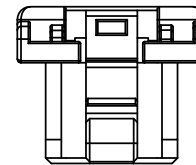

3Pin~5Pin
1 LOCK

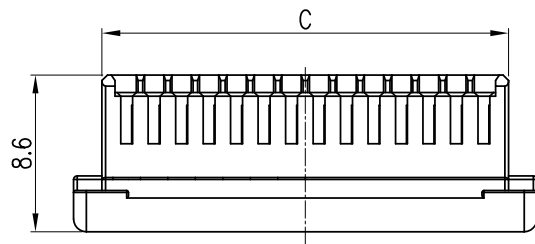

TOLERANCE	
X.	X.XXX ±0.10
X.X ±0.30	
X.XX ±0.20	Angular ±2°
	UNIT: mm
DWG TYPE. Customer Drawing	

PART NO. 1503H-XP-X-HF	
DRAWING NO. C-1503H-XP-X-HF	
APPROVED BY <i>Angus.Chen</i> 2016/06/15	CHECKED BY <i>Sun.lee</i> 2016/06/15

朝貴電子股份有限公司 CKM ELECTRONICS CO., LTD.	
TITLE. 1.5mm PITCH PLUG HOUSING	
DRAWN BY <i>Rock</i> 2016/06/15	PAGE 1 OF 3
SCALE 2.5 : 1	REV. C

C		UPGRADE DRAWING	Rock	2016.06.15
B		UPGRADE DRAWING	Rock	2015.04.07
REV.	ECN NO	REVISION RECORD	DRAW	DATE

1 RoHS



2

3

4

5

6

A

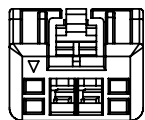

2Pin

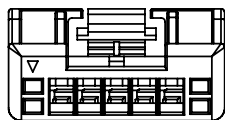

5Pin

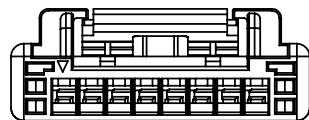

8Pin

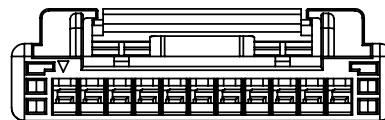

11Pin

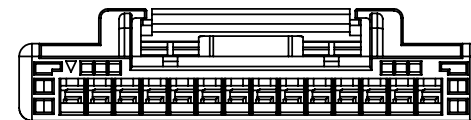

14Pin

B

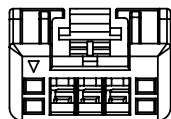

3Pin

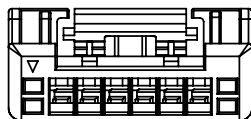

6Pin

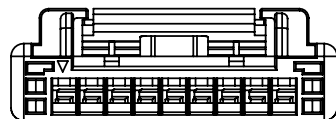

9Pin

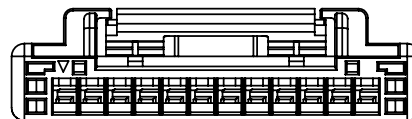

12Pin

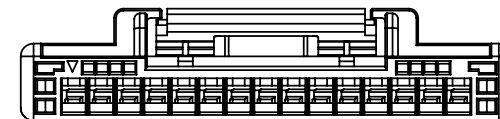

15Pin

C

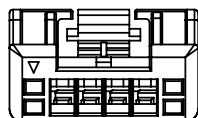

4Pin

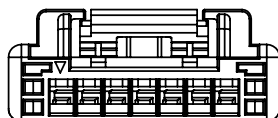

7Pin

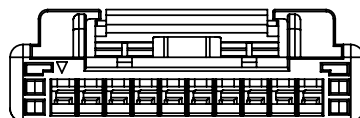

10Pin

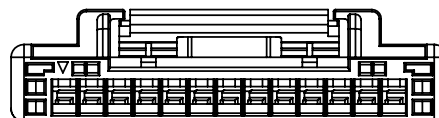

13Pin



D

TOLERANCE		PART NO.		朝貴電子股份有限公司	
X.	X.XXX ±0.10	1503H-XP-X-HF		CKM ELECTRONICS CO., LTD.	
X.X	±0.30	DRAWING NO.		TITLE.	
X.XX	±0.20	C-1503H-XP-X-HF		1.5mm PITCH PLUG HOUSING	
UNIT: mm		APPROVED BY	CHECKED BY	DRAWN BY	PAGE
DWG TYPE.		Angus.Chen	Sun.lee	Rock	2 OF 3
Customer Drawing		2016/06/15	2016/06/15	2016/06/15	SCALE
				2.5 : 1	
				REV. C	

C		UPGRADE DRAWING	Rock	2016.06.15
B		UPGRADE DRAWING	Rock	2015.04.07
REV.	ECN NO	REVISION RECORD	DRAW	DATE

1

2

3

4

5

6

1 RoHS



2

3

4

5

6

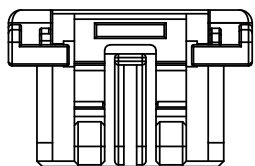

PRODUCTS
FIGURE 1

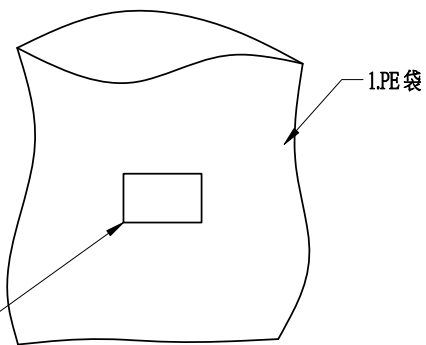
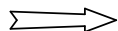

FIGURE 2

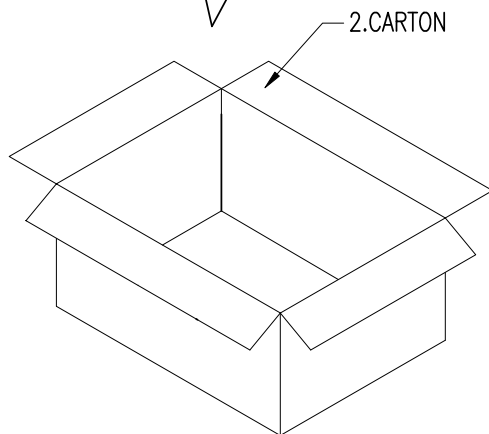

FIGURE 3

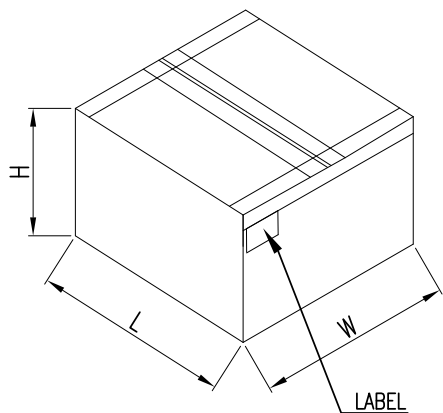

FIGURE 4

POS	PCS/BAG	PCS/CARTON	NET WEIGHT (Kg)	CROSS WEIGHT (Kg)
2	1000	20,000	3.02	3.64
3	1000	20,000	3.60	4.22
4	1000	20,000	4.22	4.84
5	1000	18,000	4.34	4.94
6	1000	18,000	4.90	5.50
7	1000	18,000	5.31	5.91
8	500	16,000	5.26	6.19
9	500	16,000	5.73	6.65
10	500	14,000	5.38	6.26
11	500	14,000	5.71	6.60
12	500	12,000	5.12	5.98
13	500	12,000	5.38	6.23
14	500	10,000	4.70	5.52
15	500	10,000	4.92	5.74

Pin	L	W	H
2P	320	220	155
3P~10P	340	340	220
11P~15P	320	320	280

TOLERANCE		PART NO. 1503H-XP-X-HF		朝貴電子股份有限公司 CKM ELECTRONICS CO., LTD.	
X. X.XXX ±0.10	Angular ±2°	DRAWING NO. C-1503H-XP-X-HF			
X.X ±0.30		APPROVED BY Angus.Chen 2016/06/15		CHECKED BY Sun.lee 2016/06/15	
X.XX ±0.20		DWG TYPE. Customer Drawing		DRAWN BY Rock 2016/06/15	
				PAGE 3 OF 3	
				SCALE 2.5 : 1	
				REV. C	

C		UPGRADE DRAWING	Rock	2016.06.15
B		UPGRADE DRAWING	Rock	2015.04.07
REV.	ECN NO	REVISION RECORD	DRAW	DATE

1

2

3

4

5

6 QMI-P12-05-01