

RoHS

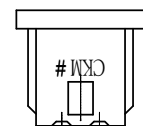
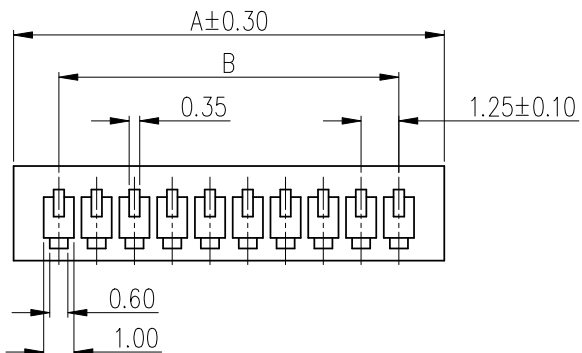

ONLY 2 CIRCUITS

NOTE:

1. MATERIALS: NYLON 66 UL 94V-0.

2. RoHS & HF COMPLIANCE.

3. BILL OF PART NO:

1251H-XP-X-HF

HF=HALOGEN-FREE

NO OF CIRCUITS: 2~15 COLOR: BLANK(NATURAL) OR A~Z

4. FOR COLOR, AVAILABILITY, DELIVERY & MOQ, CONTACT CKM.

5. DIMENSIONAL

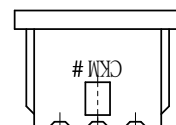
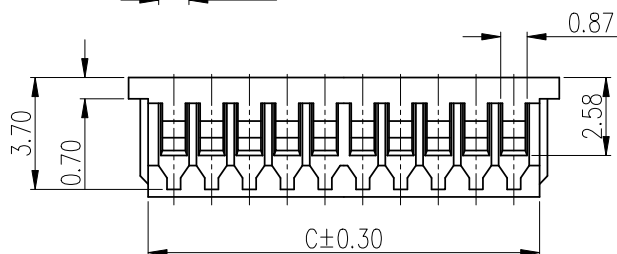
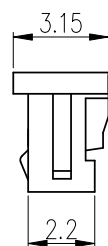

ONLY 3 CIRCUITS

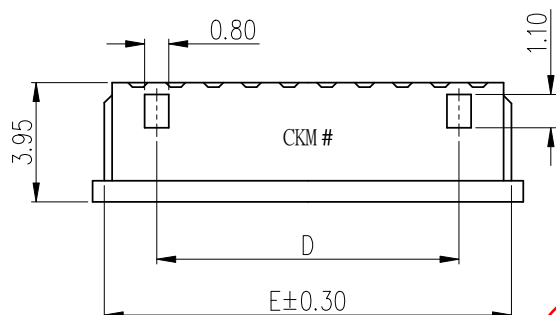
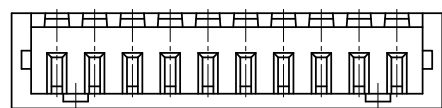

POS	A	B	C	D	E
2	4.25		2.95		3.47
3	5.50	2.50	4.20		4.72
4	6.75	3.75	5.45	2.50	5.97
5	8.00	5.00	6.70	3.75	7.22
6	9.25	6.25	7.95	5.00	8.47
7	10.50	7.50	9.20	6.25	9.72
8	11.75	8.75	10.45	7.50	10.97
9	13.00	10.00	11.70	8.75	12.22
10	14.25	11.25	12.95	10.00	13.47
11	15.50	12.50	14.20	11.25	14.72
12	16.75	13.75	15.45	12.50	15.97
13	18.00	15.00	16.70	13.75	17.22
14	19.25	16.25	17.95	15.00	18.47
15	20.50	17.50	19.20	16.25	19.72

CKM  
2016.12.29  
研發部

TOLERANCE	
X.	X.XXX ±0.10
X.X	±0.30
X.XX	±0.20
	Angular ±2°
	UNIT: mm
DWG TYPE. Customer Drawing	

PART NO. 1251H-XP-X-HF	
DRAWING NO. C-12510102-XX	
APPROVED BY	CHECKED BY

朝貴電子股份有限公司 CKM ELECTRONICS CO., LTD.	
DESCRIPTION WTB 1251 SERIES PLUG HOUSING	
APPROVED BY	CHECKED BY
DRAWN BY	PAGE 1 OF 2
SCALE 4 : 1	REV. C

C		ADDS PACKING DIAGRAM	Rock	2016.12.28
B		UPGRADE DRAWING	Rock	2015.11.03
REV.	ECN NO	REVISION RECORD	DRAW	DATE

RoHS

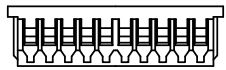

PRODUCT

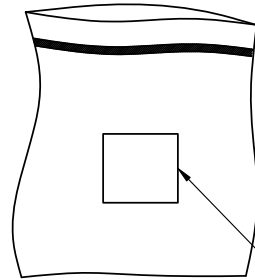
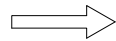

1000PCS/BAG LABEL

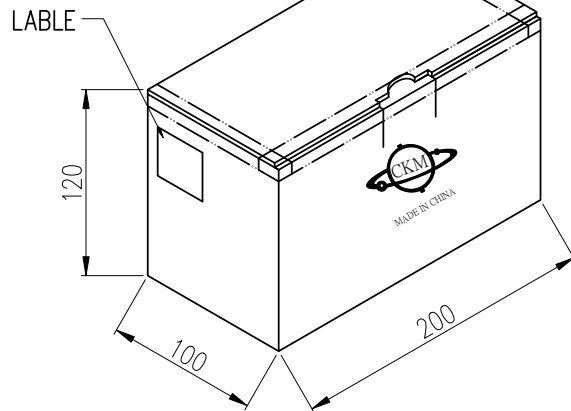
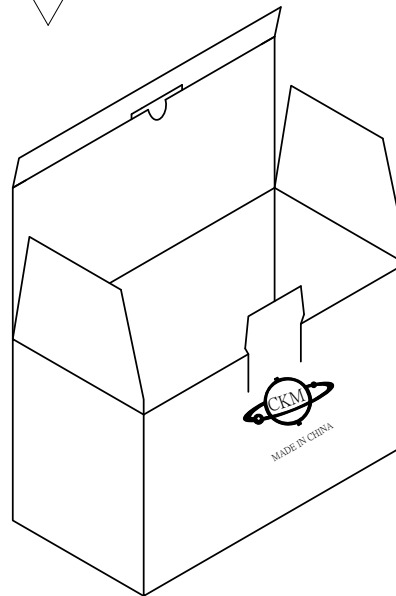

POS	PCS/BAG	PCS/CARTON	NET WEIGHT (KG)	CROSS WEIGHT (KG)
2	1000	14000	0.38	0.88
3	1000	12000	0.43	0.93
4	1000	10000	0.38	0.88
5	1000	8000	0.38	0.88
6	1000	8000	0.46	0.96
7	1000	8000	0.54	1.04
8	1000	6000	0.47	0.97
9	1000	6000	0.53	1.03
10	1000	5000	0.49	0.99
11	1000	5000	0.54	1.04
12	1000	5000	0.59	1.09
13	1000	4000	0.51	1.01
14	1000	4000	0.55	1.05
15	1000	4000	0.59	1.09



TOLERANCE		PART NO.		朝貴電子股份有限公司 CKM ELECTRONICS CO., LTD.	
X. X.X ±0.30	X.XXX ±0.10	1251H-XP-X-HF			
X.XX ±0.20	Angular ±2°	DRAWING NO.		DESCRIPTION	
		C-12510102-XX			
UNIT: mm		APPROVED BY	CHECKED BY	DRAWN BY	PAGE
DWG TYPE.				2 OF 2	
Customer Drawing				SCALE	
				4 : 1	
				REV. C	

C		ADDS PACKING DIAGRAM	Rock	2016.12.28
B		UPGRADE DRAWING	Rock	2015.11.03
REV.	ECN NO	REVISION RECORD	DRAW	DATE